

# elektor

55  
November 1979

U.K. 55p.

U.S.A. | Can. \$1.75

up-to-date electronics for lab and leisure

## Topamp

60 clean watts without  
really trying!

## I played TV games

programming tricks that  
make all the difference.

*Swinda Sijp*  
19/10/79

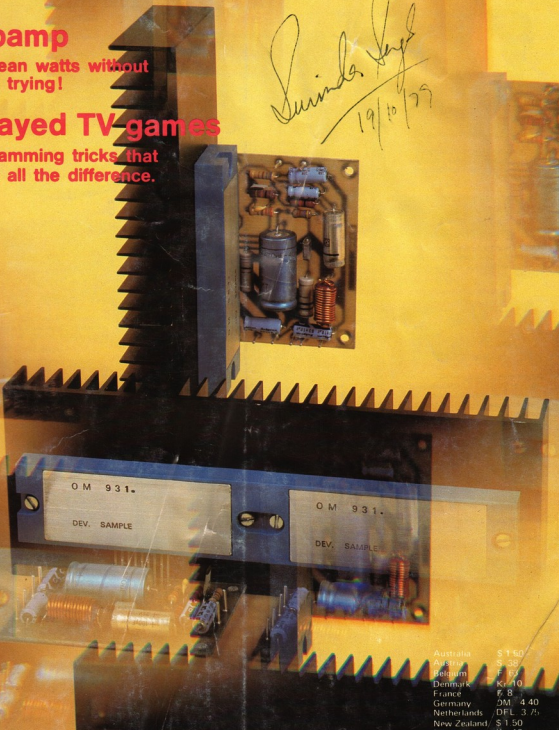

Australia	\$ 1.50
Austria	£ 3.38
Belgium	F 6.50
Denmark	Kr. 10
France	F. 8
Germany	DM 4.40
Netherlands	DFL 3.75
New Zealand	\$ 1.50
Norway	Kr. 10
Sweden	Kr. 14
Switzerland	F. 4.60

\* recommended

# elektor

# 55

# contents

november 1979  
volume 5  
number 11

page 11-14

To analyse the motion of fast-moving objects it is useful to be able to take a well-timed succession of photographs. One method is to leave the camera shutter open and produce a series of light flashes for the successive exposures. The **flash sequencer** uses only three ICs and a few other components to control five (electronic) flash guns.

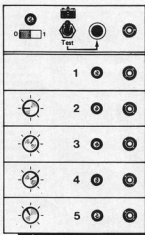

page 11-24

For one who had never played around with microprocessors, the TV games computer was a fascinating gadget! The title of the article tells the story: **I played TV games . . . and it was fun!**



page 11-34

The simple crystal-controlled **short-wave converter** is intended for use in combination with a conventional medium-wave-receiver — a car radio, for instance.

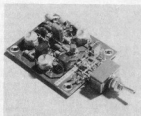

Take a hefty heatsink, a handful of passive components, a p.c. board and a brand-new audio power module, and what do you get? A very good power amplifier, with very little distortion, very little noise, very little fuss, and absolutely no calibration or adjustment!

quite a competition! . . . . . 11-01

elektor . . . . . 11-06

topamp . . . . . 11-10

Hybrid audio power amplifier modules are not particularly new: over two-and-a-half years ago, in January 1977, we discussed the subject quite extensively. What is new is the rapid advance in technology that has led to very high quality modules. The Philips types OM931 and OM961, for example, that will provide 30 or 60 very 'clean' watts, respectively, into 4 or 8 ohms.

flash sequencer . . . . . 11-14

electronics the easiest way (K. Wilson) . . . . . 11-16

It is well known that children can generate some of the most original ideas on any subject. We can only envy the straightforward simplicity of their answers to questions of a technical nature, especially when the subject is electronics . . .

remote control motor switch . . . . . 11-18

home trainer . . . . . 11-20

Budding physical fitness fanatics require an effective training program, but they must avoid overtraining them as yet untrained corpus. The circuit described here is a useful aid: it gives an indication of the amount of effort that can safely be exerted.

fuel economiser (W.H.M. van Dreumel) . . . . . 11-22

While most things are 'going decimal' it would appear that motoring costs are 'going logarithmic' and any method of saving money on the road must be greeted with enthusiasm. This particular idea is aimed at reducing the cost of acceleration (accelerating costs?).

I played TV games (2) . . . . . 11-24

Last month, we examined the basic principles of the TV games computer, and discussed the more important instructions. In this second article we will take a closer look at the rest of the instruction set, explain some useful programming tricks and list some useful routines available in the existing 'monitor' software.

short-wave converter . . . . . 11-34

ionosphere . . . . . 11-36

There are so many 'whys' associated with shortwave reception that many of us are completely in the dark about what frequency to choose, what time to listen, and what is likely to be heard. This article about the ionosphere is intended to take some of the guesswork out of shortwave listening.

low voltage dimmer . . . . . 11-39

I see your point! . . . . . 11-39

servo-controlled motor . . . . . 11-40

market . . . . . 11-41

advertisers index . . . . . UK 30

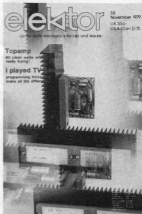

This kit  
**FREE**  
for new subscribers

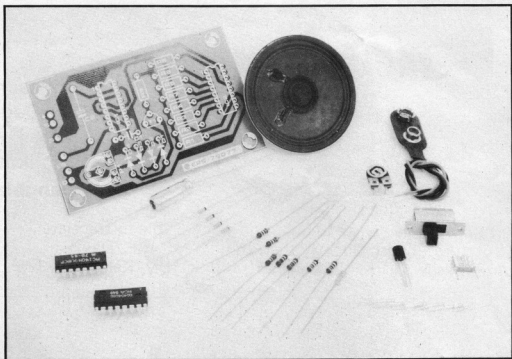

**(offer valid until December 31st 1979)**

A complete kit (including loudspeaker) for the simple sound effects generator will be sent free to all new subscribers. This offer is valid for all applications postmarked up to and including December 31st 1979.

As the name suggests, the simple sound effects generator will produce a range of sounds from that of an American police siren to one closely resembling the 'twittering' of birds.

You can become a subscriber by filling out the order card included in this issue and including the text 'subscription and free kit'. The kits will be sent out at the end of January.

# elektor

up-to-date electronics for lab and leisure

Elektor House,  
10 Longport,

Canterbury, Kent.  
Tel. (0227) 54430.

# kunt u dit lezen ?

## NEEM DAN KONTAKT OP !

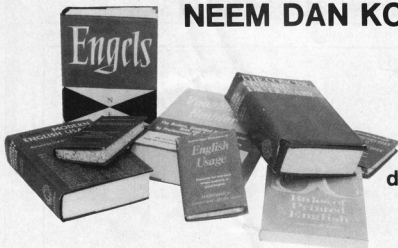

misschien  
bent U diegene  
die wij zoeken voor  
onze redactie in  
engeland.

If you think you can write in our style and are able to translate from Dutch to English fluently, then contact Mr. R.E. Day, Elektor Publishers Ltd., 10, Longport, Canterbury, Kent, CT1 1PE.

# The professional scopes you've always needed.



Super 6



Super 10

When it comes to oscilloscopes, you'll have to go a long way to equal the reliability and performance of Calscope

Calscope set new standards in their products, as you'll discover when you compare specification and price against the competition.

The Calscope Super 10, dual trace 10 MHz has probably the highest standard anywhere for a low cost general purpose oscilloscope. A 3% accuracy is obtained by the use of stabilised power supplies which cope with mains fluctuations.

The price £219 plus £17.52 VAT.

The Super 6 is a portable 6MHz single beam model with easy to use controls and has a time base range of 1µs to 100ms/cm with 10mV sensitivity. Price £162 plus £12.96 VAT.

Prices correct at time of going to press

#### CALSCOPE DISTRIBUTED BY

Maplin Electronics Supplies Ltd.  
P.O. Box 3  
Rayleigh, Essex.  
Tel: 0702 715 155  
Mail Order

Audio Electronics,  
301 Edgware Road, London W.2.  
Tel: 01-724 3564  
Access and Barclay card facilities  
(Personal Shoppers)

Watford Electronics,  
33-35 Cardiff Road,  
Watford, Herts.  
Tel: 0923 40588

# CALSCOPE



# quite a competition!

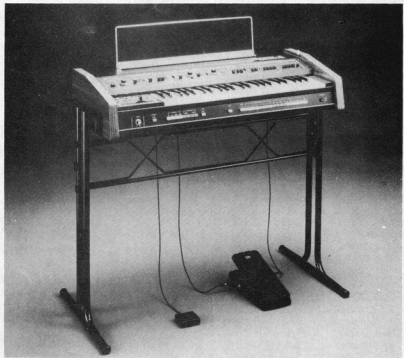

In the recent Summer Circuits edition, we presented 106 circuits — selected from over 3000 entries to our international competition. £ 10.000 worth of prizes were available for the best 20 of these, as selected by you, our readers. Well, you certainly voted — with a vengeance! In all 4414 voting cards were returned, most of which listed 10 circuits. Over 40,000 votes in all!

We soon realised that if we tried counting them by hand, the results would not be available until the middle of next year. Fortunately, we have access to a computer. Even at that, it took a total of about 40 hours of computer time!

Not to prolong the suspense further than necessary: the points scored by the various circuits are listed in Table 1. It's not so easy to spot the winner in this list, so: print-out number 2 in Table 2 gives the final positions. Congratulations, Mr. 106!

Before decoding these anonymous numbers, it is perhaps interesting to compare the slightly different voting results obtained from the cards sent in from our four different language editions. Tables 3...6 give the results from England, France, Germany and Holland, respectively. The higher totals in the German list reflect the fact that more

voting cards were returned from there. However, the general tendency in all four lists is surprisingly similar — with one or two notable exceptions: what happened to circuit no. 9 in the Dutch list? Have they forgotten what the sun looks like?!

For that matter, we had quite a bit of fun watching the intermediate results, as they became available. As the long, wet summer progressed the 'solar tracker' moved slowly up in the list and the 'moisture sensor' moved down... hard luck, sir!

And now: the prizes! These are the 20 winners, and their prizes:

# selektor

## The atmosphere of Venus

Measurements from the first spacecraft to orbit Venus are proving, upon analysis, to be an important step in understanding the evolution and thermodynamics of the planet's deep atmosphere. Success in achieving that aim would reflect into work on the difficult problems of the circulation that affects our own weather.

In May 1978 an *Atlas Centaur* rocket blasted off from Cape Canaveral in Florida carrying a *Pioneer* spacecraft which, after a journey lasting over six months, became the first spacecraft to be put into orbit around the planet Venus; the manoeuvre was successfully completed on 4th December 1978. A few days later four probes launched from a second *Pioneer* entered Venus's atmosphere at different points. The orbiter and the probes carried a variety of experiments to study the structure and composition of the planet's atmosphere.

One of the experiments on the orbiter is a radiometer measuring infra-red radiation emitted by the atmosphere and clouds, similar to radiometers on board satellites orbiting the Earth and observing our own weather. From observations with this instrument, the temperature of different layers of the atmosphere and of the clouds below the spacecraft can be inferred. The instrument has been built jointly by the Department of Atmospheric Physics of the University of Oxford and the Jet Propulsion Laboratory, Pasadena, California. It is in fact the first British-built experiment to travel to one of the planets.

Venus has, of course, been visited before by spacecraft. Three *Mariner* spacecraft from the USA have passed by the planet and nine *Venera* probes from the USSR have entered its atmosphere. But the *Pioneer 12* orbiter of last year is the first spacecraft to orbit the planet with the aim of observing the day-to-day changes in Venus's 'weather'.

### Already Known

Why is Venus such an interesting planet to Earth-bound meteorologists? To show that, first a description of what was known about Venus and its atmosphere before *Pioneer 12* and a brief look at some of the results from the latest mission:

Venus is the next planet to the Earth and is somewhat nearer to the Sun. It is about the same size as the Earth and rotates much more slowly; a solar day on Venus is 117 Earth days. The Venus

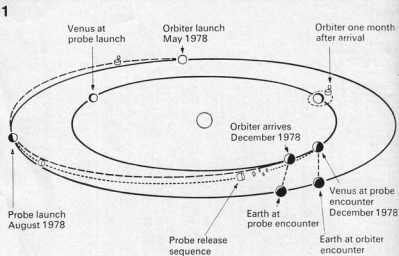

Figure 1. Trajectories of the *Pioneer* orbiter and probes.

atmosphere is very deep — equivalent to about 100 Earth atmospheres — and the cloud cover appears virtually complete, so that at visible or infra-red wavelengths no part of the surface can be seen from outside.

The first indication of a very high surface temperature on Venus, of about  $450^{\circ}\text{C}$ , came from ground-based measurements of the brightness of the planet in the microwave part of the spectrum, made about 1960. Confirmation was provided by the microwave radiometer carried aboard *Mariner 2* in 1962. By contrast, measurements of the brightness temperature in the infra-red part of the spectrum indicate a temperature of about  $-40^{\circ}\text{C}$ , a value represen-

tative of the temperature at the top of the visible clouds, which emit strongly in the infra-red region.

### Temperature Profile

So, from infra-red and microwave measurements, we can begin to construct a profile of the variation of temperature with height for the Venusian atmosphere, such as that shown in the diagram below. Further evidence for the



## 2

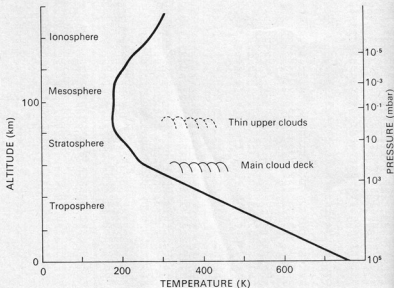

Figure 2. The atmosphere of Venus, indicating the various regions and the temperature profile.

accuracy of this profile has come from four *Venera* probes which passed close to Venus during the period 1969-72. Although theoretical calculation does not bear it out entirely satisfactorily, there is general agreement that the high temperature at the surface of Venus arises from the so-called 'greenhouse' effect. Venus's atmosphere and cloud cover together behave in a similar way to the glass in a greenhouse, in that they allow a certain amount of solar radiation to pass but are a very effective blanket to infra-red radiation leaving the planet's surface. This blanketing means that only a small amount of solar radiation needs to get through to the surface to cause quite a high temperature.

Some of the opacity in the infra-red region is due to absorption by the clouds and some to the fact that the absorption by water vapour and carbon dioxide under the high pressure of the lower Venusian atmosphere is much greater. A crucial test of the greenhouse hypothesis is to measure the proportion of the solar radiation reaching the surface of Venus in relation to the total amount arriving at its outer atmosphere. Such measurements were first made from the *Venus 8* probe in 1972; they suggested that perhaps only one-quarter per cent of the total solar flux falling on the planet penetrated to the surface. Rather better measurements from one of the *Pioneer 12* probes last year gave the higher figure of about two per cent, which seems good enough to confirm that the greenhouse mechanism is effective.

**Vital Clue**

Spectroscopic measurements from groundbased telescopes have shown that the dominant constituent of the planet's atmosphere is carbon dioxide and that there is little oxygen or water vapour. This seeming lack of water vapour led to a great deal of speculation about the composition of the clouds. A variety of sulphur compounds and mercury compounds, some of them quite exotic, were advanced as contenders. The vital clue came from very careful measurements of the polarization of reflected sunlight from the planet by two French astronomers, Coffeen and Gehrels, in 1969. These were interpreted by two Americans, Hansen and Arking, as consistent with reflection from a cloud of spherical particles of about 1  $\mu\text{m}$  radius with the rather precise refractive index of  $1.45 \pm 0.02$ . In 1973, A.T. Young from the USA put

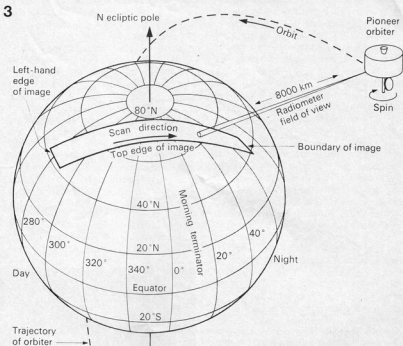

Figure 3. Scan of Venus from the *Pioneer* orbiter's infra-red radiometer.

forward convincing arguments, taking this and other evidence into account, that the cloud particles are solutions of sulphuric acid — a 75 per cent solution at the top of the clouds, at an altitude of 60 km, and a solution of about 98 per cent at the bottom of the clouds.

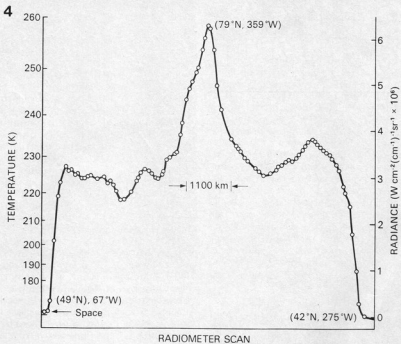

Figure 4. Brightness temperature of cloud tops in the infra-red near 11  $\mu\text{m}$  wavelength, measured across the part of the planet shown in the previous diagram.

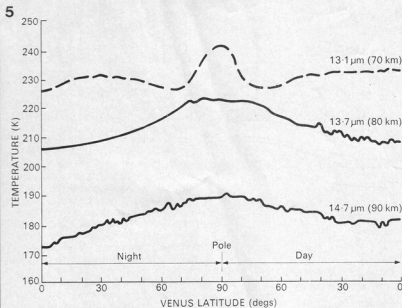

Figure 5. Scan from equator to equator through the North pole, showing the longitudinal dependence of temperature observed in three of the channels of the infra-red radiometer. (The numbers against the traces show the wavelength of each channel and the altitude represented by the information).

Young's hypothesis that the main constituent of the clouds is sulphuric acid has been substantially confirmed by direct measurements from *Pioneer 12* probes, though much larger particles, thought to be sulphur, were found in addition to sulphuric-acid droplets.

selektor  
selektor

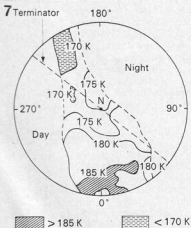

Figure 7. Temperature at an altitude of about 100 km, measured by *Pioneer* infra-red radiometer. The day side is significantly warmer (by 10 K or so) than the night side.

#### Rotation

Many observers examining photographs of Venus taken from telescopes in the ultraviolet part of the spectrum have noticed features that change with time. Particularly interesting are some which seem to have a marked tendency to recur at intervals of about four days. Evidence of rapid rotation of the upper atmosphere also comes from measurements of the difference in Doppler shift in spectral lines between opposite edges of the planet; they show velocities of about  $100 \text{ ms}^{-1}$ , consistent with four-day rotation.

Further evidence comes from the very beautiful photographs taken from *Mariner 10* which passed by Venus in 1973 en route to Mercury. Photo A is a similar photograph taken in the ultraviolet range from *Pioneer*. Cloud structure suggesting intense zonal circulation appears to be present in both hemispheres. The rapidly-moving features are visible only in ultra-violet photographs, so it is supposed that they belong to a variable, thin cloud layer at a considerably higher level than the main cloud deck, that is, at about 90 km altitude. Because the solid surface of Venus rotates so slowly, as already described, this evidence of rapid rotation of the upper atmosphere came as something of a surprise. In 1969, Schubert and Whitehead from the USA put forward the theory that the motion was caused by a travelling thermal wave induced by the motion of the Sun relative to the atmosphere. To prove their point, they carried out an experiment with a slowly-moving heat source under an annulus of mercury, and showed that

selektor  
selektor

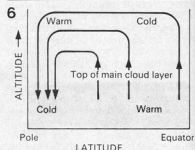

Figure 6. Simple thermally-driven circulation in Venus's atmosphere. The upper levels of cloud near the equator are heated through absorbing solar radiation. Air above the heated area rises, cooling as it does so. A compensatory sinking, with associated warming, occurs in a smaller region near the pole.

the mercury in the annulus developed a velocity in the opposite direction to that of the source and of about four times its magnitude. Comparing the dynamical properties of the upper Venusian atmosphere with the mercury in the laboratory annulus led them to argue that the ratio of atmospheric velocity to the apparent velocity of the Sun, relative to Venus's atmosphere, would be much greater than the factor of four found in the laboratory experiment.

#### Infra-Red

Further clues regarding the circulation are beginning to come in from the infra-red radiometer experiment on the *Pioneer 12* orbiter. The radiometer scans across the planet in the way shown in figure 3. Figure 4 shows the effective temperature at the top of the clouds measured along such a scan, as reported by F.W. Taylor and his co-workers at the Jet Propulsion Labora-

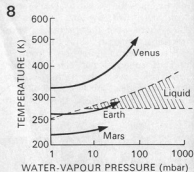

Figure 8. Runaway greenhouse effect.



# selektor

tory. The most interesting feature is the very warm part of the cloud tops at about 79 degrees North, which is interpreted as a substantial clearing in the clouds enabling the radiometer to view much deeper and warmer levels of the atmosphere. Average temperatures at various latitudes for other levels, viewed by other channels of the infra-red radiometer, are shown in figure 5. They all illustrate the rather interesting fact that the polar regions are warmer than the equator at these levels. Taken together, the measurements

temperature contrast between the day side and the night side of the planet; in fact, no difference has yet been identified in the infra-red data for levels below about 90 km. Some indications of variations with longitude are beginning to emerge from the infra-red data, and they can possibly be associated with a rapid zonal circulation. For higher levels, interpretation of the infra-red radiometer measurements by the Oxford group shows significant differences between the day and night side temperatures, as shown in figure 7, indicating that the circulation in Venus's ionosphere is of a different character than that lower down.

## The Greenhouse Effect

Returning to the lower part of Venus's atmosphere, below the clouds, measurements from the *pioneer 12* probes have

'runaway greenhouse effect', and may be described with the aid of figure 8, which compares the atmospheres of Mars, Earth and Venus.

Suppose the atmospheres began to form by gas escaping from the interiors at a time when the surface temperatures were determined by the balance between solar radiation being absorbed and long-wave radiation being emitted, at values given by those on the left-hand side of the diagram. Water vapour and carbon dioxide accumulating in the atmosphere, through the blanketing of the greenhouse effect, cause the surface temperature to rise, eventually clouds may form, intensifying the greenhouse effect and, thereby, raising the surface temperature still further, until in the end some balance is reached.

For Mars, the atmosphere is so thin that no significant cloud has formed and the blanketing effect of the atmosphere is small. On Earth, in the equilibrium state, most of the water is in liquid form, while for Venus, on these assumptions, the surface temperature has always been above the boiling point of water at the surface pressure, so we would not expect to find any liquid water. If water has been present, in a similar amount to that on Earth, it would have been the main constituent of the early Venusian atmosphere. No other gases would have been present to prevent ultra-violet solar radiation dissociating water vapour at the top of the atmosphere, so the hydrogen thereby produced would escape and the oxygen would be consumed in various oxidation processes at the surface.

The large amount of carbon dioxide remaining in the atmosphere, too, instead of in carbonates in the rocks, is consistent with this atmospheric history. Enough has been learned about the atmosphere of Venus to show that its evolutionary composition and physical structure pose very interesting problems. Our aim is to be able to model and to understand how the transport of heat, momentum and minor constituents is organized within Venus's atmosphere and how the atmosphere has evolved to its present state. Analysis of observations from *Pioneer* is already proving to be a big step towards further understanding. If we can solve these problems about Venus's atmosphere, which is so different from that of the Earth, one important outcome will be that we shall tackle the difficult problems of the circulation of our own atmosphere a great deal more confidently.

(spectrum no. 163)



point to a circulation gently rising over a large part of the equatorial and mid-latitude regions and sinking in a smaller region near the pole (figure 6); the sinking air warms as it subsides, and it clears the clouds away.

Superimposed on this overturning circulation should be the rapid zonal motion, which ensures that there is very little

confirmed that the atmosphere is 95 per cent carbon dioxide, the other five per cent being nearly all nitrogen. As already stated, water vapour is noticeably absent, compared with the amount in the Earth's atmosphere. An interesting explanation of this was put forward in 1969 and 1970 by Ingersoll, Rasool and De Burgh, in the USA. It is called the

(500 S)

# selektor

# topamp

It is surprising, in a way, that the advertising boys haven't yet come up with some phrase like 'Compact Power ®' to describe the output stage in amplifiers in the low and medium price brackets. After all, quite a few of these are equipped with a hybrid power amplifier module by now. Usually, these modules belong to the generation described in the article 'IC Audio', referred to above. But now, there is something new and better, as we shall see. A better circuit and improved thermal stability have proved possible.

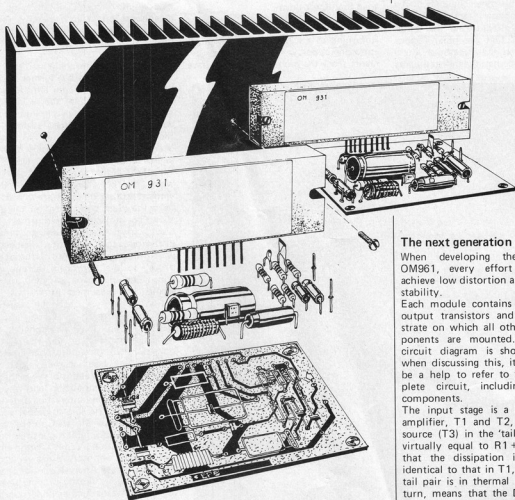

## Hybrid Hifi

Hybrid audio power amplifier modules are not particularly new: over two-and-a-half years ago, in January 1977, we discussed the subject quite extensively. What is new is the rapid advance in technology that has led to very high quality modules. The Philips types OM931 and OM961, for example, that will provide 30 or 60 very 'clean' watts, respectively, into 4 or 8 ohms. In this article, we will take a closer look at these 'lightweights with a heavy punch'.

### The next generation

When developing the OM931 and OM961, every effort was made to achieve low distortion and good thermal stability.

Each module contains two Darlington output transistors and a ceramic substrate on which all other internal components are mounted. The (internal) circuit diagram is shown in figure 1; when discussing this, it will sometimes be a help to refer to figure 2: a complete circuit, including all external components.

The input stage is a PNP differential amplifier, T1 and T2, with a current-source (T3) in the 'tail'. Resistor R3 is virtually equal to  $R1 + R2$ ; this means that the dissipation in T2 is almost identical to that in T1, so that the long-tail pair is in thermal balance. This, in turn, means that the DC offset at the output is kept to a minimum.

The output signal from T1 (across R2) is passed through a buffer stage, T4, to the driver (T5). Capacitor C1 provides frequency compensation; however, the value is smaller than usual since a rather uncommon frequency compensation circuit is used (as can be seen in figure 2).

Components T6, P1, R11 and R12 set the bias current for the output stage; the latter consists of two Darlington's, T9+T10 and T11+T12. R12 is included to counteract the effect of supply voltage variations on the bias setting. In the complete circuit (figure 2), an electrolytic is connected between the output

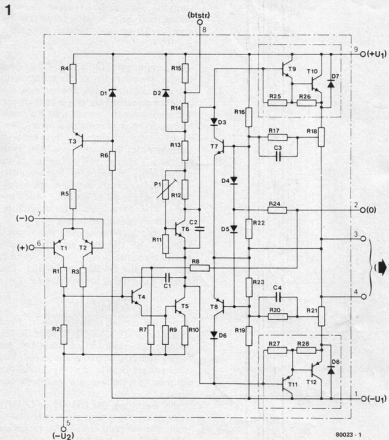

Figure 1. The internal circuit of the power amplifier modules OM931 and OM961.

#### Main specifications of the OM931 and OM961

	OM931	OM961
supply voltage	$\pm 23$ V	$\pm 26$ V
quiescent current	80 mA	80 mA
output power, 4 $\Omega$ (1)	30 W	60 W
output power, 8 $\Omega$ (1)	—	30 W
clipping level at 1 kHz, 4 $\Omega$ , d = 0.7%	40 W	40 W
THD at 1 kHz, 1 W	0.02%	0.02%
input sensitivity	0.7 V <sub>RMS</sub>	1.0 V <sub>RMS</sub>
input impedance	10 k	10 k
open-loop gain	80 dB (10,000 x)	80 dB (10,000 x)
closed-loop gain	24 dB (15.7 x)	24 dB (15.7 x)
feedback factor	56 dB (630 x)	56 dB (630 x)
frequency response at 10 dB below maximum output power	30 ... 40,000 Hz -1 dB	30 ... 40,000 Hz -1 dB
power bandwidth (-3 dB, d = 1%)	20 ... 40,000 Hz	20 ... 40,000 Hz
signal-to-noise ratio at 50 mW output power	75 dB	75 dB
signal-to-noise ratio at maximum output power	> 102 dB	> 102 dB
output DC offset voltage	$\pm 20$ mV	$\pm 20$ mV
supply ripple rejection	> 65 dB	> 65 dB
output impedance	50 m	50 m
absolute maximum supply voltage, OM931	$\pm 40$ V	$\pm 40$ V
OM961	$\pm 45$ V	$\pm 45$ V
maximum case temperature	95°C	95°C

Note (1): for THD < 0.2% at all frequencies from 20 Hz to 20 kHz (FTC specification).

(pins 3 and 4) and pin 8. This provides 'bootstrapping', with the result that the collector impedance 'seen' by T5 is much greater than R13+R14+R15, so that a high open-loop gain is obtained. Bootstrapping can cause trouble, unless due care is taken in the design. If D2 is omitted, things could go wrong... The voltage on pin 8 can easily rise above the positive supply voltage. Without D2, the voltage at the base of T9 cannot rise more than about 0.5 V above positive supply - T9 will be in saturation by then. If we consider the fact that 'clipping' in the output stage is rather nasty (the relatively long recovery time leads to audible distortion) it is obvious that it is a good idea to 'clip' at an earlier point in the circuit - even if this means sacrificing a few hundred millivolts of output swing under full drive - provided a much shorter recovery time can be achieved in this way. The bootstrap circuit provides an ideal solution: split the series resistor into two parts (R13 and R14) and connect the junction to positive supply through a diode (D2). The values of the two resistors are chosen such that D2 starts to conduct at a signal level just below that required to drive T9+T10 into saturation. With D2 conducting, the bootstrap mechanism is effectively put out of action; the remaining collector impedance for T5 is the relatively low value of R13, and so the open-loop gain collapses. This makes for a vastly improved recovery characteristic after the amplifier has been driven into clipping. Those readers who would like to know more about this are referred to the literature listed at the end of this article.

What remains, by and large, is protection circuitry: T7, T8, R16...R24, C3, C4, D3...D8. When this circuit starts to operate, T7 or T8 turns on, preventing further drive to T9+T10 or T11+T12, respectively. The base-emitter voltages of T7 and T8 depend on both the output voltage and the output current. Diodes D7 and D8 are included to protect the output devices against excessive voltage spikes, such as could occur if the protection circuit came into operation while driving a heavily inductive load.

#### Now for the external components

Figure 2 is the circuit for a power amplifier using the OM931 or OM961, as proposed by Philips in an application note. A symmetrical power supply is used, so that the loudspeaker can be DC-coupled - no output electrolytic is required. C5 is the bootstrap elco. C7 and R8 provide a well-defined load at high frequencies, to maintain unconditional stability. L1 and R7 drastically reduce the effect of a capacitive load - this might otherwise result in 'ringing'. Negative feedback from the output to the inverting input is provided by R4, R5, C3 and C4; C4, in combination with R4 and R5, provided so-called 'lead'

2

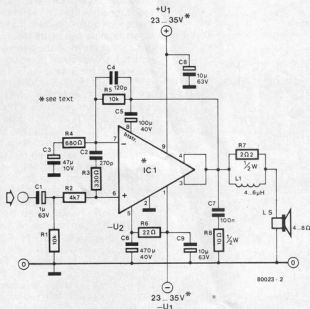

Figure 2. A complete power amplifier using either the OM931 or OM961. This circuit is a Philips design.

## Parts list

## Resistors:

R1, R5 = 10 k  
 R2 = 4k7  
 R3 = 330 Ω  
 R4 = 680 Ω  
 R6 = 22 Ω  
 R7 = 2Ω/1 W  
 R8 = 10 Ω/½ W

## Capacitors:

C1 = 1 µ/63 V  
 C2 = 270 p  
 C3 = 47 µ/10 V  
 C4 = 120 p  
 C5 = 100 µ/40 V  
 C6 = 470 µ/40 V  
 C7 = 100 n  
 C8, C9 = 10 µ/63 V

## Semiconductors:

IC1 = OM931 or OM961

## Miscellaneous:

Heatsink, 0.8°C/W (OM961)  
 or 1.4°C/W (OM931)  
 L1 = 4...6 µH; 40 turns  
 on R7, CuEm, 0.6 mm φ

compensation. Another useful precaution. At audio frequencies, the closed-loop gain is determined by R4 and R5. To be more precise, the gain is  $1 + \frac{R4}{R5}$ .

The components R2, R3 and C2 deserve special mention. In combination with R1 (in parallel with the source impedance provided by the preamplifier), these components ensure that the open-loop gain rolls off above a certain frequency. Something of this kind is necessary to keep any amplifier with feedback stable; by placing these components in front of the amplifier (effectively outside the feedback loop), there is no danger of overload *inside* the loop. TIM (Transient Intermodulation Distortion) is avoided in this way. The Table summarises the main specifications of the two amplifiers built according to the circuit given in figure 2, and using the OM931 or OM961. The figures given speak for themselves...

## Let's get cracking

A printed circuit board design is given in figure 3. This board is suitable for a single (i.e. mono) power amplifier; for stereo, two p.c. boards are required. The mechanical details of the amplifier modules themselves are given in figure 4.

When mounting the OM931 or OM961 module on the board and on the heatsink, the module should be mounted about half an inch off the board; the edge of the board will be almost flush against the heatsink. For a stereo version, the two modules can be mounted on a common heatsink, provided the latter has a sufficiently low thermal resistance.

The symmetrical supply voltages can be read off from the table. Note that, when using an unbalanced supply of the type shown in figure 5, the supply voltages given should be available at full drive.

3

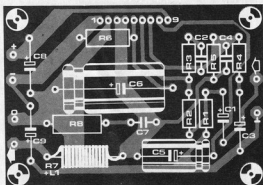
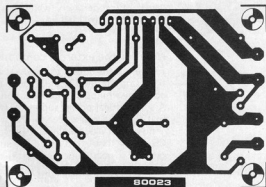

Figure 3. Printed circuit board for a single (mono) power amplifier according to the circuit given in figure 2.

4

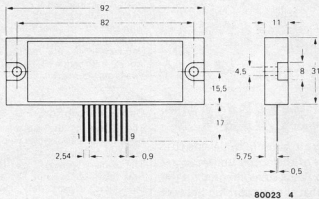

Figure 4. Mechanical dimensions of the OM931 and OM961.

5

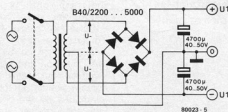

Figure 5. A symmetrical, unbalanced supply for the power amplifier(s). The current rating of the transformer and rectifier diodes depends on the number of modules to be connected, the maximum output power and the loudspeaker impedance. Details are given in the text.

Under no-drive conditions, higher voltages will be found; however, the maximum ratings ( $\pm 40$  V for the OM931 and  $\pm 45$  V for the OM961) should never be exceeded – and a safety margin should be allowed for the mains voltage rising to 10% above its nominal value.

The current rating for the transformer and rectifier in figure 5 will depend on the output power required, the load impedance, and the number of modules running on the same supply. Per module, the current consumption is as follows:

OM931, 30 W into  $4 \Omega$ : 1.25 A

OM931, 30 W into  $8 \Omega$ : 0.9 A

OM961, 60 W into  $4 \Omega$ : 1.75 A

OM961, 60 W into  $8 \Omega$ : 1.25 A

For a stereo amplifier, obviously, the total current consumption will be twice that given above.

Some care should be taken when wiring up the amplifier(s). Bad wiring can ruin the performance of even the best amplifier design; it can even lead to a considerably higher distortion percentage! This is not so surprising when one considers that the heavy current flowing in the positive supply lead during full drive only flows during the positive half of the output signal swing – effectively, it is half-wave rectified. The same applies in the negative supply lead. This means that there are an awful lot of higher harmonics floating around! And it only takes a little bit of stray capacitance or inductance for them to find their way back to the input of the amplifier...

Keep the supply wiring short and direct, therefore, and as far as possible away from the input wiring. Heavy gauge wire is also a good investment – it keeps the resistance down. The return lead from the loudspeaker should be connected direct to the supply electrolytics, not to supply common on the p.c. board. In a stereo amplifier, don't give in to the temptation to use the same lead for two jobs: separate wires should be used for all supply lines, loudspeaker returns, etc. Screened cable should be used for the input wiring. If the case is to be connected to supply common, this should be done at the input, not at the supply. All this may seem rather overdone. But it would be a pity to buy good amplifier modules and then ruin their performance by skimping in the final construction!

Finally, all due care should be taken with L1, R7 and the connections to these components. Virtually the whole of the output signal current runs through L1, and a bad joint would ruin the output damping factor.

#### Literature:

1. IC Audio, *Elektor* January 1977
2. Negative feedback – how thick to lay it on, *Elektor* March 1977
3. Equin (1), *Elektor* April 1976

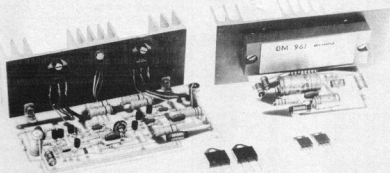

# flash sequencer

To analyse the motion of fast moving objects it is useful to be able to take a well-timed succession of photographs of the object under investigation. Ideally these photographs should be superimposed on the same frame (multi-exposure technique) so that the relationship between the various positions of the object can be examined in detail. However, the cost of the camera needed for this type of photography is out of the reach of most amateurs (and many professionals). An alternative method is to leave the camera shutter open and produce a series of light flashes for the successive exposures, thereby producing similar results. This article describes an electronic flash sequencer which generates a series of five flashes. It is intended for photographic enthusiasts who require something extra from their existing equipment. Admittedly, professional flash sequencers are commercially available but at fairly high prices and financially, therefore, not the first choice of many amateurs.

# flash sequencer

This design uses five flash units. These are fired in succession with intervals adjustable between 10 ms and several seconds. The shortest time is dependent on the flash duration and this in turn determines the resolution of the movement being analysed.

In the interests of economy, especially with regard to the total number of exposures expected, it may be considered impractical to use other than electronic flash guns (unless, of course, you grow your own bulbs).

## Circuit description.

The circuit of the sequencer consists basically of a four stage ripple counter as shown in figure 1.

The camera contact, via inverter I1, fires the first thyristor Th1 and, at the same time, triggers MMV1. At the end of its pulse duration, the negative going edge at the output of MMV1 triggers MMV2 and fires thyristor Th2. And so on until Th5 has fired. It will be obvious that it is possible to continue the chain for any number of stages — and therefore flashes. The intervals between flashes are set by potentiometers R6...R9.

Each thyristor is automatically turned off after firing when the capacitor in the flash unit becomes discharged, causing the thyristor hold current to collapse to below its critical value. To test the firing sequence without a camera, switch S1 is placed in the 'test' position and switch S2 is used to simulate the camera contacts. Any contact bounce in the camera or S2 is eliminated by the circuit itself: MMV1 will not retrigger and the flash guns require a longer time to reset.

The sequencer can also be put through its paces without flash units being connected if desired. Light emitting diodes can be used as shown in figure 2a. The thyristor rapidly charges the capacitor through the LED causing it to flash. Once the capacitor is charged, the thyristor turns off and the capacitor then discharges through the resistor across it. A 12 volt 100 milliamp power supply can be used and a circuit for this is shown in figure 2b. As an alternative the sequencer can be powered by eight size AA or C dry cells.

## Construction

The construction of the sequencer should not present any problems, all components being readily available. For the thyristors any 5 amp 400 volt type will perform satisfactorily. Plugs and sockets for connecting the flash units are available at photographic shops. The controls for exposure intervals can be realised in different ways, 500 k or 1 Mohm potentiometers can be used but switched resistors offer some marked advantages... A discrete step control permits repeatedly exact settings once the

1

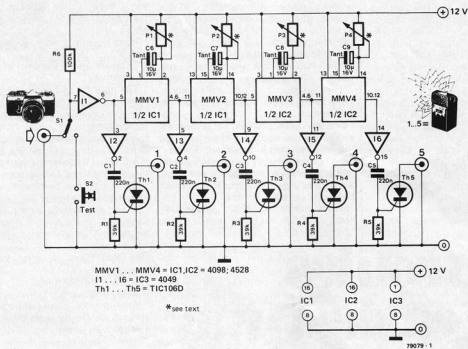

2

a

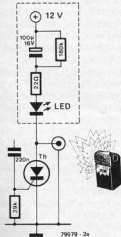

b

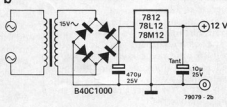

3

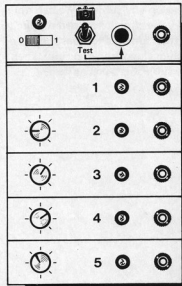

most effective interval has been established. Individual resistance values can be determined by rule of thumb: 1 k for every incremental 5 ms interval. With the 500 k or 1 Mohm suggested for R6 ... R9 this amounts to a maximum interval of 2.5 or 5.0 seconds. It should be noted that the above can

only be an approximation since the combined component tolerances can result in an error of up to 50% either way. If greater accuracy is required, one of the following methods can be used. If ordinary potentiometers have been used these could be calibrated by hand. With switched resistor banks,

each step can be trimmed with the aid of a variable resistor to be substituted by a fixed resistor once a value has been arrived at. Figure 3 shows a possible front panel layout giving an indication of the size (which can be an important parameter for the photographer).

Some of the most delightful observations about electronic communications have been boldly put to paper by primary school miniprofessors. Take these historical explanations for example.

Question: 'When was the radio invented?' Answer: 'On page 24.'

'The radio was invented in the pre-me times.'

'The Romans did not have radios. They used smoke signals in both the A.C. and D.C. times.'

Children have a knack for discarding everything but what they consider to be the most essential information. One boy brusquely wrapped up all of man's yearnings, struggles and triumphs in this eight word package: 'Progress was from electricity to radios to now.'

Here's a remark as charming as childhood itself: 'I was thinking the radio

number of ham operators we have today is an absurdly large fact of a number.'

The subject of hams has stumped many eager young scholars. Here are three more futile but imaginative explanations:

'Ham operators look something like people.'

'They are one of the chief by-products of electricity.'

'The meaning of them has a very short memory in my mind.'

The elementary school youngster's mind seems to be a vast storehouse of miscellaneous misinformation — half true, half false and wholly delightful. His fund of knowledge about electricity includes such fascinating items as these:

'Electricity has been with us forever and maybe even longer.'

'Would the average person be able to keep up with the news if it was not for electricity? The chances are 999 out of a hundred.'

'In electricity, opposites attract and vice versa.'

'If you see lightning, no you don't. You see electricity.'

'From now on, I will put both gladness and wonder in my same thought about electricity.'

Here's one I've been trying to figure out for five years: 'You should always capitalize the word electricity unless it is not the first word in the sentence.'

This next little girl seemed to be giving it all she had when she wrote: 'Correct my being wrong, but tell me true or false. Do negative charges go through electrons or through protons? I wrecked my brain trying to think which.'

But I'm afraid others are more nonchalant in their pursuit of knowledge: 'Protons are bigger than electrons in case I ever want to know.'

Psychologists tell us that half learning a fact incorrectly is often the first step to learning it right. So let's be philosophical as we buzz through these fractured facts about electrons and protons:

'100 electrons equal 1 radio program.'

'When the switch is on, electrons are constantly bumping into each other inside the wire. There is really quite an overpopulation of electrons.'

'Once I saw in an educational cartoon about how electrons move. Electrons are very interesting folks. All their ways are hurry ways.'

'Electrons carry the negative charge while protons take the affirmative.'

'Electrons are the same as protons only just the opposite.'

'I think I admire the electron more than anything else about electricity because it weighs only about one over 2000th as much as a proton but can still hold its own.'

When questioned, children offer the ever present possibility that however far from right their answers may be, the next wrong answer could be more witty and thought-provoking than the correct one. Sometimes they don't know and

# electronics the easiest way

It is well known that children can generate some of the most original ideas on any subject. We can only envy the straightforward simplicity of their answers to questions of a technical nature, especially when the subject is electronics . . .

was invented before the telegraph. When I learned different, all the thoughts I was going to say went in a swallow down my throat.'

Another tiny historian concluded: 'The Dark Ages lasted until the invention of electricity.'

Through the years, the youngest generations' fund of knowledge has proved to be a glittering gold mine of wit and unconscious wisdom, often conveniently unhampered by hard facts. Each new subject seems to be a fertile new field for off-centred interpretation and lopsided logic. Digging into facts about Marconi produced such notable nuggets as these:

'Marconi was born in 1874, supposedly on his birthday.'

'It took much hard work for Marconi to think out how to invent the radio. He had to keep thinking around the clock, twelve days a week.'

'In just a few short years he became a sensation overnight.'

'He expired in 1937 and later died from this.'

Recently a bright-eyed little radio enthusiast came up with this endorsement: 'Every time I think how the radio gives us so much fun, I have joy feels all over.'

A skeptical classmate of hers absorbed all the statistics regarding the number of ham radio operators, but got his skepticism across in one crushing statement: 'The total amount of ham operators today is more for saying than believing.'

It must run in the family. Two years later his younger sister reported: 'The



they know they don't know, but that doesn't keep their answers from being charming:

'Ideas about how radios work have advanced to the point where they are no longer understandable.'

'Did I pass the test about how to get a ham radio operator's license and why not?'

'I have found radios to be easier to listen to than to tell how they work.'

Take three small boys, mix them up thoroughly with several pounds of strange facts, then shake up with an examination and you have the perfect formula for instant confusion.

'The way vacuum tubes work, as I understand it, is not very well understood.'

'Many questions have been aroused in my mind about vacuum tubes. As a matter of fact, the main trouble with vacuum tubes is that they give more questions than answers.'

'In electricity, positives are attracted by negatives for the reason of search me.'

Often a grownup can only envy the simplicity of a child's way of expression, as is the case of the lass who remarked:

'When I learned we were going to see a movie about ham operators all over the world, I told my feet to quiet down but they felt too Saturday to listen.'

In their world of uncertainty, once they know a fact for certain, they hang on to it tenaciously, e.g.: 'Another name for the radio is radiotelephony, but I think I will just stick with the first name and learn it good.'

Children, like mountain climbers, must always make sure that their grasp on a fact is firm, even though they want to leap far beyond. Otherwise, they may find themselves trapped on a mental ledge. There is usually at least an element of truth in the most absurd answer. Sometimes they aren't wrong at all. It's just the way they put it that's so funny:

'Radio has a plural known as mass communication.'

'Water scientists have figured out how to change river currents into electric currents.'

'The best thing live wires are good for is running away from.'

'Quite a bit of the world's supply of electricity goes into the making of ham radios.'

'Many things about electronic communication that were once thought to be science fiction now actually are.'

Members of the primary school set certainly have their own opinions, and few are hesitant to express them:

'All the stuff inside a ham radio is so twisted and complicated it is really not good for anything but being the stuff inside a ham radio.'

'Electronics is the study of how to get electricity without lightning.'

How about this unforgettable remark: 'Last month I found out how a radio works by taking it apart. I both found

out and got in trouble'.

And you can't argue with the young fellow who reported: 'When currents at 200 to 240 volts go through them radios start making sounds. So would anybody.'

Just what is a vacuum? Here are five answers, fresh from the minds of nine-year-olds:

'Vacuums are made up mostly of nothings.'

'A vacuum is an empty place with nothing in it.'

'Vacuums are not anything. We only mention them to let them know we know they're there.'

'There is no air in vacuums. That means there is nothing. Try to think of it. It is easier to think of anything than nothing.'

'A vacuum tube contains nothing. All of its parts are outside of itself.'

Another lad wrote this frustrating experience: 'I figured out how a vacuum tube works twice but I forgot it three times.'

One of his classmates reported: 'When I learned how empty vacuum tubes are, I would have fainted if I knew how.'

If you're at all hazy about other parts in a radio, hang on. These next thoughts will leave you only slightly worse off than before:

'An electron tube can be heated two different ways. Either Fahrenheit or Centipede.'

'When you turn a radio on, the tubes get hot. The hotter anything gets, the faster the molecules in it move. Like if a person sits on something hot, his molecules tell him to get up quick.'

'In finding out that radio tubes get hot, the fun is in the fingers.'

'Transistors are what cause many radios to play. Transistors are a small but important occupation.'

'We now have radios that can run on either standard or daylight time.'

One student had many tussles with his spelling book. When he finished writing one particular sentence, the battleground looked like this: 'terminals do not agree with themselves spellingly and pruncingly.'

With apologies to Mr. Webster, I would like to present a pocket-size dictionary of pint-size definitions, compiled from school children's reports. Should any of them prompt Webster to turn over in his grave, he would have to do so with a smile:

'Actually, a choke coil is not as dangerous as its name sounds.'

'Electromagnets are what you get from mixing electricity and magnets together.'

'Think of a volt. Then yippee, because now you have had the same thought as Voltaire, after who this thought was named.'

Another lad had the right information, but the wrong answer: 'There are some things about electricity we are still not sure of. These things are called whats.'

If the kids don't know all the answers, they can always do what their parents

once did — try to slide by on a guess or two:

'A radio telescope is a thing you can hear programs by looking through it.'

'Current electricity is electricity that is currently in use.'

Children are so full of questions, they can't possibly wait for someone to tell them all the answers. That's why they plunge recklessly ahead on their own, like so:

'Sound travels better in water than in air because in water the molecules are much closer apart.'

'I have noticed that if a portable radio is turned in different directions, the station talks loudest behind its back.'

'Although air is hollow it is not just for looking through. It is also for having radio waves running through it and trying to answer questions about.'

'Radio waves would not be all that important to study if it were not for ears.'

'Someone in here said that FM has shorter waves than shortwave radios. Is this so? I think it is because I think I was the one that said it.' (If you can't believe yourself these days, who can you believe?)

An obviously more confident young man proclaimed: 'Much has been said about how radio waves travel. Radio waves are both hearable and talkable.'

The last word must go to this moppet who was doing well — until the last word:

'I believe the radio is one of the most important inventions of all time. Of course my father works at a radio station, so I may be a little pregnant.'

That's one young writer who would have done fine if she had just stopped while she was ahead (which is good advice for grownup writers, too).

By kind permission of 73's magazine. ■

Remote control systems for models use various ways of coding the control signals. One way is to use pulse-width modulation: pulses are sent with a repetition rate of 20 ms and a pulse length of 1.0...2.0 ms, where the pulse length defines the command.

The circuit described here belongs in this category. The position of a three-way switch is determined by the length of the pulse received. If the switch is used to control a motor, it can be arranged so that the motor turns one way if the pulse length is 1.0...1.25 ms; it is stopped for pulses between 1.25 and 1.75 ms; finally, a pulse width from

that the input pulse width is only 1.1 ms, it will have returned to logic '0' before FF1 is clocked. The Q output of FF1 will therefore become '0' and the  $\bar{Q}$  output will become '1' (C and D, respectively, in figure 2). T1 is turned on, the relay pulls in, and the motor will run, say, anti-clockwise.

While all this is going on, MMV2 and FF2 are also doing their stuff — with only one or two minor differences. The period time of MMV2 is set (by R2 and C2) to 1.75 ms — E in figure 2 — so it takes that much longer before FF2 is clocked and its Q output becomes logic 0. Note that if it was already at

# remote control motor switch

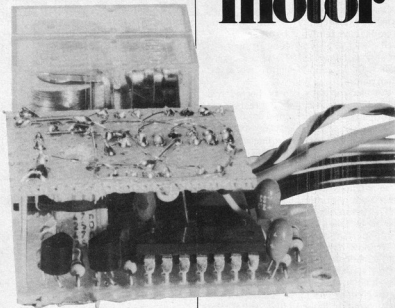

1.75 to 2.0 ms causes it to turn in the opposite direction.

The circuit is given in figure 1, and figure 2 illustrates the pulses at various points. The incoming pulses are fed to the trigger inputs of two monostable multivibrators (or 'one-shots'), MMV1 and MMV2, and to the 'data' inputs of two flip-flops (FF1 and FF2).

Let us assume that a 1.1 ms pulse is received (A in figure 2). MMV1 is triggered, so that it produces a 1.25 ms output pulse (as determined by R1 and C1). The Q output from this one-shot (B in figure 2) is used to clock FF1. With this type of 'data flip-flop', the logic level at the 'data' input is transferred to the Q output on the *positive-going* edge of the clock signal. As can be seen from figure 2, this corresponds to the end of the 1.25 ms period determined by MMV1. Since we are assuming

logic 0, it stays that way! Since T2 is controlled by FF2's Q output, this transistor will be turned off. Relay 2 drops out (or stays out), which is exactly what we want.

If the incoming pulses are made longer than 1.25 ms, the data input of FF1 will be at logic 1 when it is clocked. Its Q output will become '0', turning off T1 so that Re1 drops out. Both poles of the motor are connected to positive supply. No power, so no rotation...

Finally, if the incoming pulses are made still longer — more than 1.75 ms — the Q output of FF2 will become logic 1. Now, at last, T2 is turned on; Re2 pulls in, and the motor starts to run in the opposite direction.

So much for the main circuit. Only two points remain to be mentioned. The cross-connections between the Q output of FF1 and the R input of MMV2, and between the  $\bar{Q}$  output of FF2 and the R input of MMV1, ensure that only one of the two relays can be pulled in at any time. Strictly speaking, this is an unnecessary refinement, but it only costs two bits of wire.

Three Schmitt-trigger NAND gates, N1...N3, perform a double function. When the low-voltage (4.8 V) supply for the electronics is first connected, C5 is not charged and so the output of N3 is at logic 1. This sets FF1 and resets FF2, so that both transistors are turned off and the motor is stationary. Furthermore, if the supply to the motor (8.4 V) drops below a level determined by P1, the flip-flop consisting of N1 and N2 changes state, again turning off the motor. This is done to prevent damage to the accumulator by excessive discharge.

Since quad NAND gate packages contain four NANDs, there's one left.

1

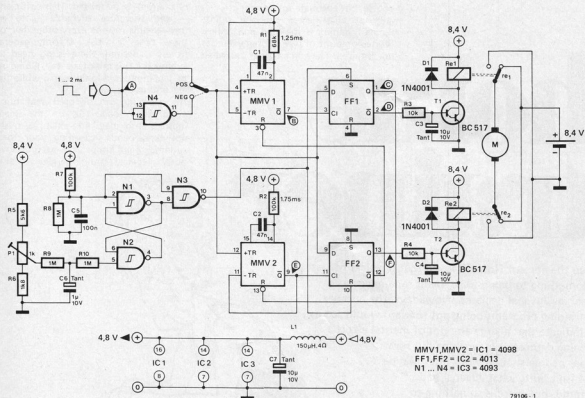

This can prove useful if the circuit is to be triggered by negative control pulses: N4 can be wired in series with the input, to invert them!

It was mentioned in passing that a low-voltage supply is used for the electronics proper. Since only a few milliamps are required, this supply can be derived from the battery that powers the receiver. L1 and C7 can be added to smooth the supply — although in practice L1 will often prove unnecessary. The supply for the motor will normally be provided by a separate accumulator. The voltage used, of course, depend on the motor used; the relays must also pull in reliably on the same voltage (and have sufficiently heavy-duty contacts!). If a different supply voltage is used, the value of R5 (in series with P1) will have to be altered accordingly. The voltage at the wiper of P1 should be set to approximately 2,2 V with fully-charged batteries. The motor will then be switched

2

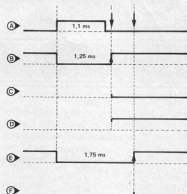

off when the voltage drops by about 10%. Another good way to adjust P1 is to set it so that the motor is turned off automatically when it is held stationary under power. Note that this adjustment should be done very slowly, since C6 and R9 provide a considerable delay! Once the protection circuit has cut in, the only way to reset it is to disconnect the 4.8 V supply for a few seconds. The same applies when setting up the model: if the battery that powers the motor is installed last, the protection circuit will already have detected a 'low' battery. As before, the 4.8 V supply will have to be disconnected for a few seconds. If this is felt to be a nuisance, a reset push-button can be included in parallel with R8 and C5.

One final note. If the motor is found to run the wrong way, the connections to the motor should be reversed — *not* those to the battery! Otherwise the protection circuit won't work . . .

Budding physical fitness fanatics require an effective training program, but they must avoid overtraining their as yet untrained corpus. The circuit described here is a useful aid: it gives an indication of the amount of effort that can safely be exerted in the course of the training course. It is only a coarse indication, of course, but adequate for normal use.

All specialists agree on one point: regular training is the key, and only a limited amount of well-chosen exercises are required. The home trainer described

and another half-minute break; and so on. At the outset, five one-minute work-outs are enough for one day. After about four weeks, an extra minute can be added; from then on, a further minute is added every two weeks until finally, after 12 weeks, a total of 10 minutes hard work (with five minutes relaxation) is permitted. It is sufficient — and therefore advisable — to go through this routine every other day, or three times a week. If only general fitness is desired, there is no need to extend the five minutes a day. Going up to ten minutes is only worth while for real enthusiasts.

All exercises can be used that bring more than one-sixth of the main muscles into play: for example, push-ups, knee-bends, touching your toes, running, high jumps and so on. Obviously, special training gear (home

# home trainer

Even the ancient Romans knew that physical fitness is something to be desired: 'mens sana in corpore sano', as Juvenal declared. Nowadays, the number of training programs being put forward would seem to indicate that a large amount of mental effort is being dedicated to working out how other people should 'work out'. Maybe this isn't quite what Juvenal had in mind, but there is something to be said for 'sensible gymnastics' — if nothing else, at least a good training program can help to improve physical fitness with a minimum of effort. Apparently, in our highly efficient society, this is a desirable goal.

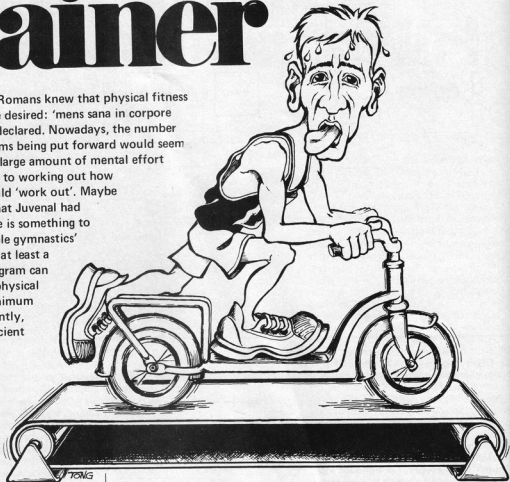

## timer for systematic PT

here is based on a system evolved at Leeds University: so-called Circuit Training. This system has the advantage of combining two desirable goals: improving stamina and toning up the most important muscles.

Several variations of the same basic system exist, and one of the most popular ones is the basis for this circuit. The idea is to work hard for one minute and then take a 30-second breather; then another minute of strenuous exer-

trainers of one kind or another) can also be used. Equally obviously, it is a good idea to use various different types of exercise — one minute of each, say.

During the one-minute exercise periods, you are supposed to really exert yourself. Keeping one eye on the clock is not easy under these circumstances. And this is where the 'Home Trainer' comes in. At the end of the first minute it gives a (welcome?) indication that it is time for a breather; after a further indication

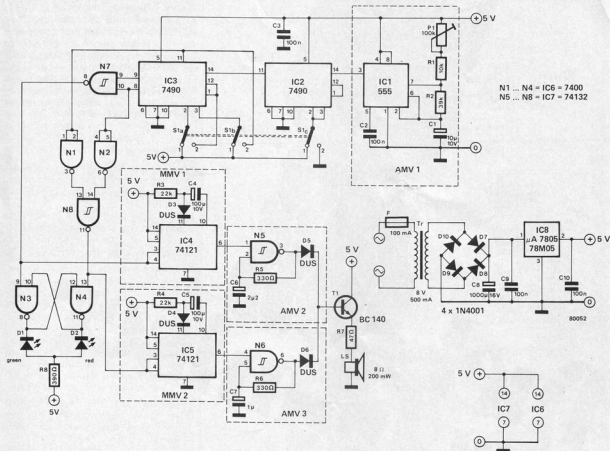

it recalls you to your duty, and so on. Two different frequencies are used, so that there is little danger of getting out of step. The tones last for about two seconds. In case of doubt, two LEDs clearly indicate what you are supposed to do: Green for Go and Red for Stop. Like traffic lights, only without the amber.

### The circuit

From the description given above it is to be expected that the circuit will be fairly simple. It is. A single 555 timer and a few standard TTL ICs do the whole job. The 555 timer gives the basic clock pulses, at one-second intervals. A counter, consisting of two 7490s, derives the 60-second and 30-second intervals from these clock pulses. One minute after the circuit is first switched on, the output of NAND gate N7 goes to logic 0. This triggers monoflop MMV1. During the two-second output period of this monoflop, a multivibrator (N5 and associated components) produces a 750 Hz 'take-a-breather' indication.

At the same time, the logic 0 from N7 causes a flip-flop (N3 and N4) to flip — or should it be flop? — so that the

green LED is turned off and the red LED is turned on. As mentioned earlier, red means Stop...

After a further 30 seconds, the counter (IC2 and IC3) resets. The output of N8 now becomes logic 0. This triggers monoflop MMV2 (IC5), turning on the 1500 Hz 'get moving' signal for two seconds and resetting the N3/N4 flip-flop (if it flipped before, it will now flop, or vice versa) so that the green LED lights. Two clear and unambiguous indications that it is time to get back on the job.

The only calibration point in the circuit is the 100 k preset potentiometer in the basic clock generator circuit. The calibration procedure is as easy as it is

### Table

first through fourth week	5 x 1 minute
fifth and sixth week	6 x 1 minute
seventh and eighth week	7 x 1 minute
ninth and tenth week	8 x 1 minute
eleventh and twelfth week	9 x 1 minute
from thirteenth week	10 x 1 minute

Note: for enthusiasts only! The rest of us keep to 5 x 1 minute every other day.

obvious: P1 is adjusted until the one-minute exercise interval lasts for one minute. A few seconds over or under are unlikely to affect the effectiveness of the training program.

A straightforward 5 V power supply, as shown in the circuit, is sufficient. The total current consumption is less than 150 mA, so a bell transformer will be more than adequate.

Using the circuit is even easier than calibrating it. After switching on, S1 is set to position 1 — 'Reset' — so that the counters are reset to zero. Having dressed suitably and moved the furniture out of the way, S1 is set to position 2. The first strenuous minute starts: operation 'physical fitness by the clock' is under way. The merciless mechanical mentor will let you know when to let up and when to get going again. The only mental exercise required of the ardent (perspiring) student is to keep track of the number of rounds. As mentioned earlier, five one-minute sessions are enough for most people. Real enthusiasts can derive their training program from the accompanying table.

One final word of advice: those who are in any doubt at all about their bodily health *must* consult a doctor before embarking on any strenuous exercise. ❏

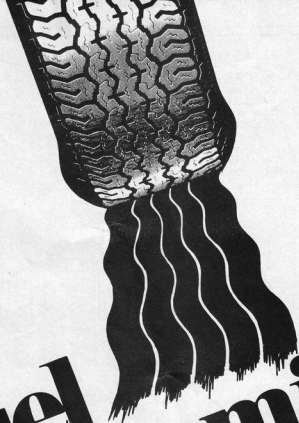

# fuel economiser

a swinging project for sound drivers

Not a novel method of mounting loudspeakers but an audible aid to smoother (and therefore cheaper) motoring. While most things are 'going decimal' it would appear that motoring costs are 'going logarithmic' and any method of saving money on the road must be greeted with enthusiasm. This particular idea is aimed at the cost of acceleration (accelerating costs?). In other words, if you resisted the impulse to put your foot down quite so hard all of next week, how much petrol will you save?  
How do you try it?

W.H.M. van Dreumel

It is, of course, possible to calculate fairly precisely how much energy it takes to accelerate your particular car from, say, 20 to 40 miles per hour (no, please do not phone the A.A. or R.A.C.) Briefly the figures go like this: if your car is initially traveling at  $x$  metres per second and  $t$  seconds later your speed has increased to  $y$  metres per second, the acceleration ( $a$ ) was  $y - x$  metres per second in  $t$  seconds, or

$$a = \frac{y-x}{t} \text{ (m/s}^2\text{)}.$$

Why ( $\text{m/s}^2$ )? Simple, because speed is measured in metres per second and not miles per second (we've been doing it all wrong folks).

How does all this help us? In short, it is possible to determine the rate at which the speed of a car is increasing by an acceleration-measuring device: an ac-

celerometer. It is a fact that a 'smooth' driver rarely accelerates at more than  $1 \text{ m/s}^2$ . How does your figure stand — are you a  $5 \text{ m/s}^2$  driver?

## The accelerometer

How do we measure acceleration in a practical sense? There is a very simple method right before the eyes of far too many motorists: those little mascots dangling on a string. When the car is stationary or moving at a constant speed, the mascot hangs straight down (disregarding any possible complications due to the relativity theory). If the speed is increased the mascot will swing back on the string; the greater the acceleration the farther it will swing back (see figure 1).

The accelerometer in the fuel economiser is based on this principle. As shown in figure 2, the heart of the device is 'a weight on a plate on a rod in a box'... home made of course. As the car accelerates the weighted strip will swing on its spindle, and in doing so, it varies the frequency of an audio oscillator. At low acceleration rates, the output frequency will be so low that it is virtually inaudible. Increasing acceleration will produce a low buzz. Really taking off will be rewarded by a distinct tone. A sort of Swinging Strip Controlled Oscillator (SSCO), really.

The mechanical details can be seen in figure 2. The strip can be made from a piece of copper laminated board with a collar soldered to the upper end. A bolt is passed through this and fitted to a base plate allowing the strip to rotate

freely. The side view in figure 2c will clarify this. At the lower end of the strip, a heavy nut can be used as a weight — how heavy can best be found by experiment.

As can be seen in figures 2b and 2c, an LED and an LDR are mounted on either side of the box so that the LDR cannot 'see' the LED when the strip is hanging straight down. The LED should only start to illuminate the LDR after the strip has swung back through a small angle. Different indication characteristics can be achieved by tailoring the shape of the cut-out in the strip: an almost square shape as shown will give a fairly abrupt changeover from a low to a high frequency while a wedge shape will give a more gradual increase.

The box for the prototype was made by soldering pieces of copper laminated board together and the author actually filled the bottom of this box with heavy engine oil to damp the movement of the weighted strip. However, that is up to our more wealthy readers to experiment with. We have yet to try porridge, as a cheaper alternative.

The complete unit can be mounted at a suitable point in the car. The strip must be free to swing back, of course, and it must hang straight down — two restrictions that limit the choice of suitable positions in the car somewhat. If the unit proves too sensitive — beeping at even quite modest acceleration — there are two solutions. One is to use a heavier weight, but this may involve dismantling half the unit. The alternative may therefore be preferable: mount the box at an angle, in such a way that the strip rests against the side of the box when the car is stationary. A certain minimum acceleration is then required before it even starts to move.

### The circuit

The astable multivibrator circuit that provides the warning tone is shown in figure 3. It is a standard '555' configuration, that has been described in various guises more than once . . . The output frequency depends on the value of the LDR, R1 and C1. As more or less light falls on the LDR, the frequency will be higher or lower. The range of frequencies produced can be modified by selecting different values for C1.

A high impedance loudspeaker should be used with  $60\ \Omega$  being an absolute minimum. If only a lower impedance loudspeaker is available then a series resistor must be used to make the total resistance over  $60\ \Omega$ .

We are not suggesting that this article will prevent the next oil crisis, but it may help to make a small reduction on the motoring costs of our readers. 'Since using the Elektor accelerometer Fuel Economiser, I'm now a  $1\text{ m/s}^2$  driver'.

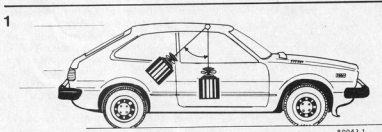

Figure 1. A hanging weight will swing backwards when the car accelerates.

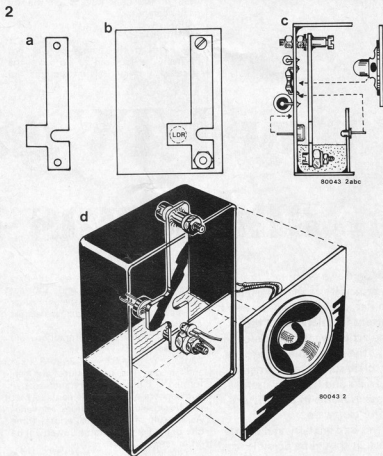

Figure 2. Mechanical details of a more sophisticated version of the weight on a string principle.

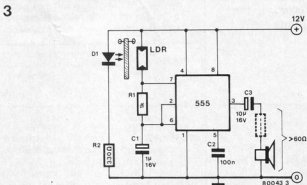

Figure 3. The circuit of the audio oscillator.

The load, Store, Branch, Compare, 'Miscellaneous' and 'Program Status' instructions were all dealt with last month. As illustrated in Tables A . . . E in that article, these instructions are sufficient for quite interesting little programs. However, as the extended version of the same program on the new ESS record illustrates, programs can be made rather more sophisticated by the use of the remaining instructions: Arithmetic, Logical and Rotate. (The Input/Output instructions cannot be used in the basic version of the TV games computer).

#### Arithmetic

Even though the computer will not normally be required to do sums, the so-called arithmetical instructions are

add or subtract operation, provided the 'with carry' bit (bit 3 in the PSL) is set. If the WC bit is not set, Carry or Borrow information is ignored - in practice, this has proved even more useful!

- The Inter-Digit Carry bit (IDC): this gives the Carry or Borrow information that applies between the lower four and the upper four bits in the register affected. This information can be ignored when binary arithmetic is performed, but it may be essential when doing decimal calculations.
- The Overflow bit (OVF): since large numbers (greater than 7F) can be interpreted as negative numbers, things can go wrong in an addition. For instance,  $70 + 28$  will give the result 98 - but this is equivalent to a

# I played TV games . . . . (2)

## . . . . and it was fun!

Last month, we examined the basic principles of the TV games computer, and discussed the more important instructions. In this second article we will take a closer look at the rest of the instruction set, explain some useful programming tricks and list some useful routines available in the existing 'monitor' software.

With this information, and a little practice, it should be possible to develop quite interesting programs. At this moment, we've got half-a-dozen ideas, and we hope to get them on ESS records in the not-too-distant future!

quite useful. As shown in Table 8, a complete set of add and subtract instructions are available; the only other instruction under this heading is 'decimal adjust register'.

Both addition and subtraction are straightforward:

$03 + 05 = 8$ ;  $19 - 02 = 17$ ;  $28 + 13 = 3B$ ; and so on. The calculations are performed in 8-bit true binary and negative numbers are two's complement, so that the hexadecimal calculations are valid. As a result of these calculations, three bits in the Program Status Lower will be set or reset:

- The Carry/Borrow bit (C): to be precise, this is set to 1 by an addition that generates a carry, and to 0 by a subtraction that generates a borrow. However, in most cases it is sufficient to know that this bit will be interpreted correctly in any following

negative number (-68). This type of ambiguous result is indicated by the setting of the overflow bit: if two positive numbers are added or subtracted and the result is 'negative' the OVF bit is set. Similarly, if a positive result is obtained from a calculation on two negative numbers.

So much for addition and subtraction. In practice, it is often sufficient to know that clearing the 'WC' bit results in a straightforward calculation, without any unexpected 'carries' or 'borrows'.

#### Decimal Adjust Register

This instruction allows BCD sign magnitude arithmetic to be performed on packed digits. Full details are given in the instruction manual. So far, we have got by quite well without it; the only time it might have been useful (for a

Table 8

description	Arithmetic		
		example	comments
Add to register Zero	(ADDZ)	81	R0: = R1 + R0
Add Immediate	(ADDI)	84xx	xx = data
Add Relative	(ADDR)	88yy	yy = displacement
Add Absolute	(ADDA)	8Czzzz	zzzz = address
Subtract from register Zero	(SUBZ)	A1	R0: = R0 - R1
Subtract Immediate	(SUBI)	A4xx	xx = data
Subtract Relative	(SUBR)	A8yy	yy = displacement
Subtract Absolute	(SUBA)	ACzzzz	zzzz = address
Decimal Adjust Register	(DAR)	94	



decrementing time display on the screen) it seemed simpler to subtract six at each '0 - F crossing', as follows:

```
F707 TMI, R7
9802 BCFR
A706 SUBI, R7
etc.
```

### Logic

The instruction set includes AND, Inclusive Or (IOR) and Exclusive Or (EOR) instructions, as summarised in Table 9. The corresponding logic operations are given in Table 10; for most practical applications, it is easier to describe the effects in words:

#### AND

An AND instruction causes two groups of 8 bits to be compared; in the result, only those bits will be logic 1 that were 1 in both of the original groups. This instruction can therefore be used as a 'data mask'. As an example, assume that some type of delay routine or 'clock' is counting in R3, and that the three least significant bits are used to determine the screen colour. This can be achieved as follows:

```
R3 LODZ, R3
4407 ANDI, R0
8408 ADDI, R0
CC1FC6 STRA, R0
```

After 'screening out' the five higher bits by means of the AND instruction, the 'Background enable' bit is added, and the result stored in the PVI.

#### Inclusive Or

Once again, two groups of eight bits are compared; in this case, however, all bits that are logic 1 in either of the two groups will be 1 in the result. Another way of looking at this is to say that only those bits will be logic 0 in the result that were 0 in both of the original groups. A complementary data mask, in other words!

Both AND and IOR instructions can also be used to set or reset one or more bits in a group of eight, without affecting the others. In the example given above, for instance, if the contents of R3 are to be used for both screen and background colours:

```
03 LODZ, R3
6408 IORI, R0
CC1FC6 STRA, R0
```

The Inclusive Or instruction is added to ensure that the Background enable bit is always set.

#### Exclusive Or

Quite apart from its 'logical' function, this instruction can be used as a 'selective inverter'. If we take one group of 8 bits as the original data and xor it to a second group, the result will be that some of the bits in the first group will be inverted, as specified in the second group. Complicated? Not really. Each bit in one group specifies what happens to its partner in the other: if it's logic 1, the partner is inverted; if it's logic 0, the corresponding bit in the other group is

PHILIPS

PROGRAMMABLE VIDEO INTERFACE (PVI) 2636

PHILIPS

microprocessor  
2650

FIGURATION

signetics

signetics

Table 9

		Logic	
description		example	comments
AND to register Zero	(ANDZ)	41	R ≠ R0
AND Immediate	(ANDI)	44xx	xx = data
AND Relative	(ANDR)	4Byy	yy = displacement
AND Absolute	(ANDA)	4Czzzz	zzzz = address
Inclusive Or to register Zero	(IORZ)	61	
Inclusive Or Immediate	(IORI)	64xx	xx = data
Inclusive Or Relative	(IORR)	68yy	yy = displacement
Inclusive Or Absolute	(IORA)	6Czzzz	zzzz = address
Exclusive Or to register Zero	(EORZ)	21	
Exclusive Or Immediate	(EORI)	24xx	xx = data
Exclusive Or Relative	(EORR)	28yy	yy = displacement
Exclusive Or Absolute	(EORA)	2Czzzz	zzzz = address

not affected. A few examples. Let us assume that the 'data' (i.e. one of the two groups of 8 bits) is FF in all cases: 1111 1111. 'EOR, FF' will invert all bits, giving 00 as result. Similarly, 'EOR, C0' will invert the first two bits (C0 = 1100 0000), so the result will be 0011 1111 = 3F.

Finally, a more practical example. As mentioned last month, scanning one

column of the keyboard will always give a logic 1 for the four least significant bits. The 'C' key, for instance, (column address 1E8A) is decoded as 8F. This unwanted data can be removed as follows:

```
0C1E8A LODA, R0
240F EORI, R0
```

Note that it is just as easy (and perhaps more 'logical') in this case to use an

AND instruction as data mask: 'ANDI, R0' will produce the same result.

Table 10

## Rotate

The 'Rotate Register Right' and 'Rotate Register Left' instructions do exactly that: the data in the specified register is shifted one place to the left or right, respectively. If the 'With Carry' bit in the PSL is reset, the data will shift around the loop — out one end and in the other. When the WC bit is set, however, things get rather more complicated: the 'Carry' and 'Interdigit Carry' bits also come into play. Fortunately, there is no need for a long-winded explanation: Figure 2 illustrates all the possibilities!

## Tricks and gimmicks

This is where the fun begins! While playing around with the games computer — and studying the monitor software, for that matter — we found several useful little programming tricks. Experienced programmers have assured us that most of them are well-known, but maybe some of our readers are as uninformed as we were ...

### EORZ, R0

In machine language: '20'. The data in register zero is XORed to the data in register zero; this means that if a bit is logic 1 it will be inverted, but any logic 0's will be left alone. The result? 00 in register 0! The advantage is that this instruction is one byte shorter than the equivalent '0400', for LODI, R0.

### IORZ, R0

This instruction ('60' in machine language) has no effect on the data in register zero. However, an operation is performed — even if it has no effect — and so the Condition Code bits are set according to the data in R0: 01 for 'positive', 00 for 'zero' and 10 for 'negative'.

### Multiplication and division

Rotating the data in a register one step left is equivalent to multiplying by two (provided no overflow occurs, but that can be checked). Similarly, shifting one step right is a division. What about multiplying by three? No problem:

```
C1 STRZ, R1
D1 RRL, R1
81 ADDZ, R1
```

Job done.

The original data, in register zero, is copied into register one; after multiplication by two, it is added to the original data in register zero.

### LODI as scratch

In the course of a program, it is often necessary to update certain data at regular intervals. For instance, the horizontal position of an object may be modified from the keyboard. Once new data is loaded in the PVI, it can be left

there indefinitely and the horizontal position will remain unchanged. However, the awkward thing is that this position data can not be read back from the PVI when a new position update is required. The only solution is to keep track of the PVI data by also storing it at some point in the 'normal' memory. When a position update is required, the present data are retrieved from this 'scratch-pad memory', updated, and the new data stored both in the PVI and in the memory scratch.

All this is nothing new. However, in practice one little trick has proved useful. Since the program itself is stored in random access memory, there is nothing to stop you modifying instructions in the course of the program. If we assume, for instance, that the data in register one is to be added to the existing horizontal position data, this can be achieved as follows:

```
0400 LODI, R0
81 ADDZ, R1
C87C STRR, R0
CC1FCA STRA, R0
```

The second part of the Load Immediate instruction is used as 'scratch', so the existing horizontal position data is loaded into R0 when the first instruction is carried out. The data in R1 is then added, and the new position information is restored in the scratch. Finally, the same new information is transferred to the PVI.

Compare this routine to a more 'normal' one, using address 08C0, say, as scratch-pad memory:

```
0C08C0 LODA, R0
81 ADDZ, R1
CC08C0 STRA, R0
CC1FCA STRA, R0
-----
```

08C0 = scratch

Admittedly, the third instruction can be

### Logic operations

The logic operations treat each corresponding pair of bits in the two specified (8-bit) data bytes according to the following truth tables:

	Bit A (0...7)	Bit B (0...7)	Result
AND	0	0	0
	0	1	0
	1	0	0
	1	1	1
IOR	0	0	0
	0	1	1
	1	0	1
	1	1	1
EOR	0	0	0
	0	1	1
	1	0	1
	1	1	0

### Examples

In the following examples, the original data in Register Zero is assumed to be 0F.

'ANDI, R0, 33' (4433): data A = 0F = 0000 1111  
data B = 33 = 0011 0011  
result = 03 = 0000 0011

'IORI, R0, 33' (6433): data A = 0F = 0000 1111  
data B = 33 = 0011 0011  
result = 3F = 0011 1111

'EORI, R0, 33' (2433): data A = 0F = 0000 1111  
data B = 33 = 0011 0011  
result = 3C = 0011 1100

Note that all three logic operations can also be considered as 'bit-mask' operations. After an AND operation, only those bits in the original data (data A) remain logic 1 that were specified by the ones in the bit mask (data B). Conversely, after an Inclusive Or instruction only those bits in data A will remain logic 0 that were specified as 'of interest' by the zeroes in data B. Finally, an Exclusive Or operation causes those bits in data B to be inverted that correspond to the ones in data B.

2

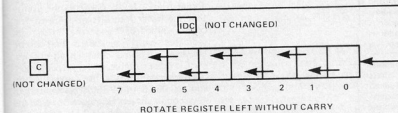
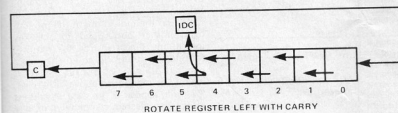
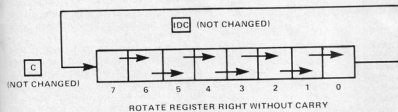
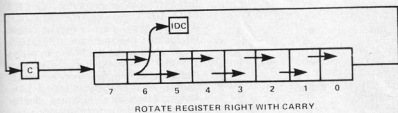

replaced by a 'Store Relative, Indirect' version (CBFB, to be precise) — but even so, this routine is noticeably longer than the one given above.

#### Modifying Absolute addresses

The same trick described above can be used to modify an absolute address as required in the course of a program. The test pattern program on the new ESS record, for instance, uses this system to load a whole string of initial data into the PVI. The corresponding section of program (with a few modifications, to give a more interesting result!) is given in Table 11.

During each pass through the loop, the following sequence is carried out. First, the second byte of the desired absolute address is retrieved from the 'data store' ('LODA, I-R1') and stored at address 09D5 — i.e. the third byte of the STRA instruction. Then the data is retrieved

(the second LODA, I-R1 instruction) and stored in the PVI at the address currently specified. Note that this address is *not* 1F00, no matter what the listing says: '1Fxx' would be more accurate, where xx is the address data retrieved by the first LODA, I-R1 instruction.

There are, of course, all sorts of variations on the same principle. The thing to realise is that it can be very useful to modify actual instructions in the course of a program. Bearing this in mind, practical examples will be found regularly when developing programs!

#### Using monitor routines

The complete monitor software is stored in ROM, so there is no way to change it. However, it is stored at normal memory addresses, so there is nothing to stop you using monitor subroutines as part of a different program. In most cases, the only restriction is that the monitor routine must end with an unconditional return instruction (RET, UN = 17). Furthermore, initial data must sometimes be set up correctly before starting the monitor routine. However, even with these restrictions, we have drawn up an extensive list of useful subroutines. Some have already been tried; the rest are still theoretical possibilities.

#### Keyboard scan

A complete keyboard scan routine, including contact debouncing and double-key reject, starts at address 0181. As it stands, it uses the lower register bank. If this is awkward, the routine can be started at address 0183 after clearing the 'With Carry' and 'Carry' bits in the Program Status Lower.

Two further points must be noted: the routine must be repeated twice in succession (preferably at consecutive frames, using the VRLE bit); furthermore, memory location 089F must be cleared before the first scan. A complete

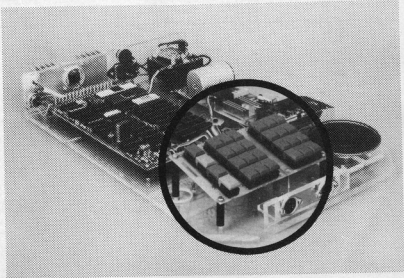

Table 11

09C7	7620	PPSU, I1	
09C9	056E	LODI, R1	
09CB	0D49E2	LODA, I-R1	(address)
09CE	C805	STRR, R0	
09D0	0D49E2	LODA, I-R1	(data)
09D3	CC1F00	STRA, R0	(09D5 = scratch)
09D6	5973	BRNR, R1	
09D8	0C1E88	LODA, R0	
09DB	F420	TMI, R0	Return to
09DD	9879	BCFR	monitor if 'PC'
09DF	1F0000	BCTA, UN	
09E2	50 0C	data-address	
09E4	50 1C	data-address	
09E6	50 2C	data-address	VC 1 ... 4
09E8	50 4C	data-address	
09EA	FE 0D	data-address	
09EC	FE 1D	data-address	
09EE	FE 2D	data-address	VOD1 ... 4
09F0	FE 4D	data-address	
09F2	22 0A	data-address	
09F4	42 1A	data-address	HC 1 ... 4
09F6	62 2A	data-address	
09F8	82 4A	data-address	
09FA	AA C0	data-address	size
09FC	09 C1	data-address	
09FE	09 C2	data-address	colour
0A00	19 6C	data-address	
0A02	00 00	data-address	
0A04	00 01	data-address	
0A06	00 02	data-address	
0A08	74 03	data-address	
0A0A	44 04	data-address	SHAPE 1
0A0C	74 05	data-address	
0A0E	44 06	data-address	
0A10	44 07	data-address	
0A12	77 08	data-address	
0A14	00 09	data-address	
0A16	00 10	data-address	
0A18	00 11	data-address	
0A1A	00 12	data-address	
0A1C	75 13	data-address	SHAPE 2
0A1E	45 14	data-address	
0A20	76 15	data-address	
0A22	45 16	data-address	
0A24	45 17	data-address	
0A26	75 18	data-address	
0A28	00 19	data-address	
0A2A	00 20	data-address	
0A2C	00 21	data-address	
0A2E	00 22	data-address	
0A30	77 23	data-address	
0A32	25 24	data-address	SHAPE 3
0A34	25 25	data-address	
0A36	25 26	data-address	
0A38	25 27	data-address	
0A3A	27 28	data-address	
0A3C	00 29	data-address	
0A3E	00 40	data-address	
0A40	00 41	data-address	
0A42	00 42	data-address	
0A44	70 43	data-address	
0A46	50 44	data-address	SHAPE 4
0A48	60 45	data-address	
0A4A	50 46	data-address	
0A4C	50 47	data-address	
0A4E	50 48	data-address	
0A50	00 49	data-address	

Start address: 09C7. Return to monitor by operating PC key.

routine is given in Table 12. After the presets and a 'wait for VRLE' routine, the first scan is requested: '3F0183 BSTA, UN'.

After the scan, the two highest bits in R1 indicate the 'scan status'. If bit 6 is at logic 1, this was the first scan and so a further scan is required; the program branches back to the 'wait for VRLE' routine. After the second scan, bit 6 is at logic 0 and bit 7 indicates whether one key was depressed during the two scans: it is one if this is the case, and zero if no key or two or more keys were operated. Note that 'key operated' (bit 7 is logic 1) corresponds to a negative number, so the condition code will be set to 10.

A further possibility, not used in this routine, is to reset only bit 7 at address 089F. Bit 5 in R1 will then indicate if a key is (still) depressed.

To get back to the routine given in Table 12, after the second scan (when reaching address 0FE6, in other words) the lower five bits in R1 give the number of the operated key. The corresponding hexadecimal numbers are listed in figure 3a; the indications at the top left-hand corner correspond to the key indications suggested for the monitor routine. It should be noted that these numbers are *only* valid if bit 7 in R1 is logic 1, as mentioned above; otherwise, '00' will appear if the data at address 089F was cleared completely, or else the previous key code if only bit 7 was reset.

These key codes can be ideal for many applications. It is particularly useful that the lower four bits are identical for both keyboards, and the fifth bit indicates which keyboard was used. However, in some cases an alternative code is more suitable, and this is obtained by the second part of the routine (from address 0FE6 to 0FF5). The translated key codes shown in figure 3b will be transferred into Register 0.

This code has several advantages. For the sixteen 'number keys', the data simply corresponds to the key number. All other keys are distinguished by the fact that bit 7 is logic 1; furthermore, bit 6 is logic 1 for the '+' and '-' keys only. Similarly, bit 5 uniquely identifies the RCAS and WCAS keys. The only disadvantage is that the upper control (UC), lower control (LC) and reset keys (the latter only if the key is wired as part of the keyboard) are all translated as 80, since they are not used in the monitor routines.

Finally, an additional subroutine using the keyboard scan routine is included from address 0FF6 on: 'Wait for key release'. This routine simply repeats the keyboard scan until the indication '30', for 'no key', is obtained.

#### Some little routines

After the extensive discussion of the keyboard scan routines, it should come as a welcome relief to take a look at some little subroutines.

**clear duplicates**

The instruction '3F009E' (BSTA, UN, 009E) causes 'FE' to be loaded into the four 'vertical offset duplicate' addresses: 1F0D, 1F1D, 1F2D and 1F4D. The result is that only the basic objects will appear on the screen, without any duplicates.

Alternatively, any other desired vertical offset can be loaded by first storing it in R0 and then starting the subroutine at address 00A0.

Only register zero is used in this routine.

**clear objects**

All object shape data can be cleared by storing 00 at all addresses from 1F00 to 1F4F. This is accomplished by a subroutine starting at address 016E. Any other data present in R0 (FF, say) can be loaded into all these addresses by starting the subroutine at address 016F. Registers used: R0 and R2.

**split register**

The 8 bits in a register can be written as two hexadecimal characters. Sometimes it is useful to actually separate these two characters. A subroutine, starting at address 035E, splits the data in R1. If the original data in this register was 'XY', the subroutine will leave '0Y' in R1 and load '0X' into R0.

**Text display routines**

There are, of course, several other small subroutines available in the monitor software. However, most of these are closely related to the text display routines, and so it is easier to treat them as a separate group.

**initiate PVI**

This subroutine (starting at address 0161) presets the PVI for text display. It has the following effects:

- objects size 2 ('AA' in 1FC0);
- correct colour (yellow objects, blue screen);
- '00' in 1FC3 (form/pos);
- sound off;

**Table 12**

0FD0	20	EORZ, R0	presets for keyscan	} keyboard scan and decode
0FD1	CC089F	STRA, R0		
0FD4	7712	PPSL, RS, COM		
0FD6	7509	CPSL, WC, C		
0FD8	0C1FCB	LODA, R0	wait for VRLE	
0FDB	F440	TMI, R0		
0FDD	9879	BCFR		
0QDF	3F0183	BSTA, UN	Gosub 'Keyscan repeat if 1st scan	
0QFE2	F540	TMI, R1		
0QFE4	1872	BCTR	} load '30' if no key else load translated code and return	
0QFE6	01	LODZ, R1		
0QFE7	1A05	BCTR		
0QFE9	0430	LODI, R0		
0QFEB	7510	CPSL, RS		
0QFED	17	RETC, UN		
0QFEE	451F	ANDI, R1		
0QFF0	0D6122	LODA, I/R1		
0QFF3	7510	CPSL, RS		
0QFF5	17	RETC, UN		
0QFF6	3B58	BSTR, UN	(keyscan no key)	} wait for key release, then return
0QFF8	F430	TMI, R0		
0QFFA	987A	BCFR	return	
0QFFC	17	RETC, UN		

Registers used: R0, R1, R2, R3;

Subroutine levels used: 2 for 'keyboard scan',  
3 for 'wait for key release'.

- disable score ('AA' in 1FC8 and 1FC9);

- clear objects ('00' in 1F00...1F4F). Note that all object position data is set to 00 by this routine! Furthermore, the background data is *not* cleared; the background is merely made 'invisible' by giving it the same colour as the screen.

Registers used: R0, R1, R2.

**message data**

When writing a text on the screen, a lot of complicated data must obviously be loaded into the 'object shape' area in the PVI. Fortunately, several characters are pre-programmed in the monitor software, as listed in Table 13. The first 28 (up to and including the 'x' sign) are deliberately programmed; the rest are 'accidental'. A complete scan of all characters and other shapes that can be

obtained in this way is included as one of the routines in File 2 on the ESS 006 record.

To obtain one line of text on the screen, the codes derived from Table 13 must be loaded into addresses 0890...0897: eight characters in all for each line. If spaces are required, the code '17' must be stored in the corresponding addresses. In some cases, it may be useful to first store 8 spaces and then store the one or two characters required. There is a subroutine for this, starting at address 02D9; it uses R0 and R2. A program example may serve to clarify the points discussed so far. The routine given in Table 14 (derived from Table 7 in last month's article) will produce a complete display of the most useful characters.

After the usual 'interrupt inhibit' instruction, the first step is to initiate

**3**

System keys	Left-hand keyboard			Right-hand keyboard		
UC 0F	RCAS 03	WCAS 07	C 0B	D 13	E 17	F 1B
STRT 0E	BP 02	REG 06	8 0A	9 12	A 16	B 1A
LC 0D	PC 01	MEM 05	4 09	5 11	6 15	7 19
RESET 0C*	-	+ 04	0 08	1 10	2 14	3 18

\* Note that this code is only obtained if this key is wired as part of the normal keyboard - not if it is wired direct to the reset input, as in the suggested keyboard layout.

System keys	Left-hand keyboard			Right-hand keyboard		
UC 00	RCAS 90	WCAS 93	C 0C	D 0D	E 0E	F 0F
STRT 8A	BP 84	REG 87	8 08	9 09	A 0A	B 0B
LC 80	PC 8D	MEM 81	4 04	5 05	6 06	7 07
RESET 80*	-	+ E0	0 00	1 01	2 02	3 03

30 = no key operated

\* see note under figure 3a.

the PVI, as described above: '3F0161'. Then R3 and R1 are preset, for the total number of characters (42 = 2A) and the number of characters per line (07) respectively; the desired character codes are stored from address 0930 on.



The 'load 8 spaces' routine is included as the next step ('3F02D9'). Not that it is strictly necessary in this case (we're already loading seven characters in each line, and one more space could easily be added), but it serves to illustrate the principle. The following small loop (from 090C to 0912) transfers the first line of code numbers (from address 0953 on) to the 'message line scratch' (from address 0890 on). We now come to the next monitor subroutine:

#### load Mline

This monitor subroutine (at address 020E) translates the codes stored in the message line scratch to the corresponding shape data for the four objects, and stores the results in a 'display scratch' (from address 0800 to 088F, for all six lines!).

Since this routine uses all four active registers (R0 ... R3), it would alter the character count data in R3. One solution would be to use the Load Immediate instruction at address 0907 as scratch, as described earlier. In this program, an alternative solution is used: the upper register bank is selected before branching to the subroutine.

The next step is to check whether all characters, for all six lines, have been loaded. As long as this is not the case the program branches to address 0927, bringing us to the next subroutine:

#### scroll

To be more precise, this subroutine (from address 02CF) should be listed as 'scroll and load 8 spaces in Mline'. It has the following effects:

- all object display data in the display scratch is moved up one line, from sixth to fifth, from fifth to fourth, and so on; the data for the first line is lost;
- the code for 'space' (17) is loaded in the eight message line scratch positions.

Since this routine uses registers 0, 1 and 2, it is again padded by register-bank-

Table 13

character	code	character	code	character	code	character	code
0	00	A	0A	P	14	?	5F
1	01	b	0B	r	15	..	8A
2	02	c	0C	=	16	n (1)	AA
3	03	d	0D	space	17	!	BB
4	04	E	0E	+	18	T	BC
5	05	F	0F	-	19	!	DF
6	06	G	10	:	1A	:(2)	E6
7	07	L	11	x	1B	.	F7
8	08	I	12			!(3)	A2
9	09	n	13				

#### Notes:

- (1) this n is slightly larger than the 'official' version (code 13), and looks better between capitals.
- (2) similarly, this colon is larger than that obtained by code 1A, which can be useful.
- (3) the exclamation mark is too small, actually, but no better version exists ...
- (4) the 0 (code 00) can be used as the letter O; similarly, a 5 makes a good S and a 2 will pass for a Z.

Table 14

0900	7620	PPSU, I1	
0902	3F0161	BSTA, UN	(clear/initiate PVI)
0905	072A	LODI, R3	
0907	0507	LODI, R1	
0909	3F02D9	BSTA, UN	(load 8 spaces)
090C	0F4930	LODA, I-R3	(messline data)
090F	CD4890	STRA, I-R1	
0912	5978	BRNR, R1	
0914	7710	PPSL, RS	
0916	3F020E	BSTA, UN	(load Mline)
0919	7510	CPSL, RS	
091B	5B0A	BRNR, R3	
091D	0C1E89	LODA, R0	
0920	F410	TMI, R0	wait for '+' key release
0922	1879	BCTR	
0924	1F0038	BCTA, UN	return to monitor
0927	7710	PPSL, RS	
0929	3F02CF	BSTA, UN	(scroll)
092C	7510	CPSL, RS	
092E	1B57	BCTR, UN	
0930	5F A2 17 8A 17 E6 F7	sixth line	} DATA
0937	02 16 17 18 19 1A 1B	fifth line	
093E	AA 13 00 14 15 05 BC	fourth line	
0945	0E 0F 10 12 DF 11 BB	third line	
094C	07 08 09 0A 0B 0C 0D	second line	
0953	00 01 02 03 04 05 06	first line	

Start address: 0900

select instructions. Unnecessary, in this case, since the only register data that must be preserved is that in R3—but once again included to illustrate the principle.

After this routine, the program branches back to address 0907, to load the next line.

Once all six lines have been loaded, the branch instruction at address 091B will not be executed: the data in R3 are now zero. An uncommon program ending follows:

— wait for '+' key release — the program is started by operating this key, and the microprocessor is so fast that it will have finished the program before you have time to release the key!

— return to monitor at address 0038. This transfers control back to the monitor program in such a way that it takes care of putting the text on the screen, without first writing any message of its own!

In most cases, however, this easy way out will not be possible. A further

monitor subroutine is then required to get the message on the screen:

### display six lines

The six lines on the screen each consist of all four objects; lines 2...6 are actually the duplicates, of course. To get the desired text on the screen the object shape data for each line must be retrieved from the display scratch at the correct moment, and stored in the object shape areas in the PVI.

The monitor subroutine that does this starts at address 0055; it uses registers R0, R1 and R2. To obtain a correct display: the 'COM' bit in the PSL must be set (instruction: 7702 = PPSL, COM). Furthermore, control must be transferred to this routine at the end of each frame; the return from subroutine will not occur before the sixth line has been displayed. This means that all further program checks or other routines can only be executed just before or during the 'frame end'.

As an illustration, the program given in Table 14 can be modified according to Table 15. All text display routines are now incorporated in the program. However, the disadvantage will be obvious when the PC key is operated: initially, the monitor will scroll, reload the data from message line scratch to display scratch, scroll again, and then add the line 'PC='. All this doesn't improve the display ...

Table 15

- change the instruction at address 0024 to '1F095A' (instead of 1F0038);
- add the following section of program:

095A	0C1FCB	LODA, R0	
095D	F440	TMI, R0	wait for VRLE
095F	9879	BCFR	
0961	0C1E88	LODA, R0	
0964	F420	TMI, R0	return to monitor if 'PC'
0966	1C0000	BCTA	
0969	7702	PPSL, COM	display 6 lines
096B	3F0055	BCTA, UN	
096E	186A	BCTR, UN	

Table 16

0900	1F0958	BCTA, UN	
0903	B480	TPSU, sense	vertical interrupts only
0905	16	RETC	
0906	B440	TPSU, flag	
0908	1808	BCTR	
090A	7640	PPSU, flag	set/reset flag on alternate frames;
090C	20	EORZ, R0	keyboard scan routine
090D	CC089F	STRA, R0	
0910	1B02	BCTR, UN	
0912	7440	CPSU, flag	
0914	3F0181	BSTA, UN	
0917	9A38	BCFR	(no key)
0919	01	LODZ, R1	
091A	451F	ANDI, R1	translate key code
091C	0D6122	LODA, I/R1	
091F	E4E0	COMI, R0	
0921	182E	BCTR	branch if '+' key
0923	F480	TMI, R0	
0925	1C0000	BCTA	return to monitor if control key
0928	C804	STRR, R0	
092A	3F02CF	BCTA, UN	save data in R0 and scroll
092D	0400	LODI, R0	
092F	D0	RRL, R0	
0930	D0	RRL, R0	R0 x 8
0931	D0	RRL, R0	
0932	0608	LODI, R2	
0934	82	ADDZ, R2	
0935	C1	STRZ, R1	
0936	0D4961	LODA, I-R1	load Mline
0939	CE4890	STRA, I-R2	
093C	5A78	BRNR, R2	
093E	3F020E	BSTA, UN	
0941	0C1E8A	LODA, R0	
0944	6C1E8C	IORA, R0	
0947	6C1E8D	IORA, R0	wait for key release
094A	6C1E8E	IORA, R0	
094D	44F0	ANDI, R0	
094F	9870	BCFR	
0951	3F0055	BSTA, UN	display 6 lines
0954	7420	CPSU, II	wait for interrupts
0956	187C	BCTR, UN	
0958	7620	PPSU, II	
095A	3F0161	BSTA, UN	clear/initiate PVI and set COM bit
095D	7702	PPSL, COM	
095F	1873	BCTR, UN	

### Interrupt facility

Last month, our advice regarding the interrupt facility could be summed up in three words: Don't use it. However, we didn't follow our own advice: witness the 'space shoot-out' program on the new ESS record!

Not that we consider ourselves expert in this field, but at least we now have some experience to pass on. Two or three tricks, in particular.

### Selecting interrupts

The PVI generates interrupt requests each time an object (or duplicate) is completed, and at the end of each frame. As long as the Interrupt Inhibit bit in the Program Status Upper is not set, all of these interrupt requests will be acknowledged. No matter what caused the interrupt (object 1 complete? duplicate 3 complete? end of frame? or whatever ...), the results will be the same: the interrupt inhibit bit is set by the processor, the running program is interrupted, and the program section starting at address 0903 is run as a subroutine.

If we assume that only the end-of-frame interrupt is of interest in a program, all others must be ignored. This is not too difficult: the 'sense' bit in the PSU is logic 1 at the end of the frame, so the interrupt subroutine at address 0903 can be started as follows:

```
0903 B480 TPSU, sense
0905 36 RETE
```

```
0961 05 BC 0A 15 BC 17 17 17 data 0
0969 0E 0E 10 12 AA 17 17 17 data 1
0971 0A AA 0F 0A AA 10 17 17 data 2
0979 0D 0E 0B 56 BC 17 17 17 data 3
0981 0E AA 0D 17 17 17 17 data 4
0989 0E 12 AA 0D 0E 17 17 17 data 5
0991 0E AA 0D 0E 17 17 17 17 data 6
0999 0F 12 AA 17 17 17 17 data 7
09A1 0F 56 AA 17 17 17 17 data 8
09A9 11 00 11 17 17 17 17 data 9
09B1 05 14 0A 05 05 17 17 data A
09B9 15 12 10 00 11 0A 0D 0E data B
09C1 AA 12 0C 0E 17 17 17 data C
09C9 0A 0A 15 0D 12 10 17 data D
09D1 0A 0E BC BC 17 17 17 data E
09D9 10 0E AA BC 12 11 0E 17 data F
```

If the sense bit is not set, the TPSU instruction will result in the condition code 10. The 'return and enable interrupt' instruction (RETE) is then executed, terminating the interrupt subroutine! Only if the sense bit proves to be logic 1, at the end of the frame, will the following interrupt routine be executed. Usually, that is, because there is one minor problem — but we'll come to that in a minute.

A more extensive interrupt select procedure is also possible. In the 'space shoot-out' program mentioned above, the program actually starts as follows:

```
0900 1F09B BCTA, UN (to main program)
0903 B480 TPSU, sense
0905 1C0A10 BCTA (to vertical interrupt routine)
0908 1F09D5 BCTA, UN (to object interrupt routine)
090B 7E20 PPSU, II (main program starts here)
```

In this case, if the sense bit is set the conditional branch at address 0905 will be executed, starting the end-of-frame interrupt routine. Otherwise, this branch instruction will be ignored and the following (unconditional) branch will start the object-complete interrupt routine. The latter starts with a further check routine:

```
0905 0C1FCA LODA, R0 object 3
0908 F492 TMI, R0 complete?
090A 36 RETE return if not
```

The final result is that only two basic interrupt requests will be acknowledged: frame-end and object 3 (or duplicate 3) complete. All other object or duplicate complete interrupts will be ignored.

When testing this program, one problem was found: Sometimes, the frame-end routine was missed. This error was traced to the fact that an 'object 3 complete' interrupt just before the frame end initiates the corresponding routine — and the latter 'over-runs' the frame end, so that no vertical interrupt was found! The solution, in this case, was simple: make sure that no 'object 3 complete' interrupts can occur just before the end of the frame, by selecting a suitable sequence of 'vertical offset duplicate' values.

#### Interrupt enable

A closer look at the program section given above (addresses 0900 to 090B) will lead to a surprise: the main program starts (at address 090B) by setting the interrupt inhibit bit! This means that no interrupt requests will be acknowledged — so what's the point of including interrupt routines?

Obviously, at some point in the program the interrupt inhibit bit must be reset. It is, after storing all kinds of initial data in the PVI and presetting a whole series of 'scratch' bytes in the program. Then, at address 09D1 to be precise, the following two instructions are inserted:

```
09D1 7420 CPSU, II } wait for
09D3-1B7C BCTR, UN } interrupts
```

The processor will go round and round this loop, until an interrupt occurs. The interrupt routine will then be executed (again setting the interrupt inhibit bit, automatically); at the end of the interrupt routine, a 'return' instruction will cause the processor to jump back into

Table 17

0900	1F0990	BCTA, UN	
0903	B480	TPSU, sense	vertical interrupts only
0905	16	RETC	
0906	B440	TPSU, flag	flag on
0908	1804	BCTR	alternate frames
090A	7640	PPSU, flag	
090C	1B02	BCTR, UN	
090E	7440	CPSU, flag	
0910	0D1FCC	LODA, R1	
0913	0E1FCD	LODA, R2	save joystick
0916	C90B	STRR, R1	data
0918	CE095C	STRR, R1	
091B	3F0055	BSTA, UN	display 6 lines
091E	0702	LODI, R3	
0920	0602	LODI, R2	
0922	0500	LODI, R1	joystick data! (IFCC)
0924	B440	TPSU, flag	
0926	1802	BCTR	
0928	0604	LODI, R2	
092A	0418	LODI, R0	
092C	CC096D	STRR, R0	
092F	04E0	LODI, R0	
0931	CC0984	STRR, R0	presets for
0934	04CD	LODI, R0	subroutine
0936	CC0985	STRR, R0	
0939	0E4963	LODA, I-R2	
093C	CC0987	STRR, R0	
093F	CC098A	STRR, R0	
0942	3F035E	BSTA, UN	split register
0945	3F0967	BSTA, UN	
0948	0498	LODI, R0	
094A	CC096D	STRR, R0	presets for
094D	040E	LODI, R0	subroutine
094F	CC0984	STRR, R0	
0952	046D	LODI, R0	
0954	CC0985	STRR, R0	
0957	01	LODZ, R1	
0958	3F0967	BSTA, UN	
095B	0500	LODI, R1	joystick data! (IFCD)
095D	F84B	BDRR, R3	
095F	7420	CPSU, II	wait for interrupts
0961	1B7C	BCTR, UN	
0963	89 71 41 29		address data

(continued on next page) →

#### Note:

at addresses 096D, 0983 and 0985 either of the alternatives given can be entered. The program modifies these instructions as required!  
Start address: 0900.

this 'wait' loop. Note that the interrupt inhibit bit is reset in the loop, so that it is unimportant whether a 'normal' return instruction (17, say) or a return-and-enable-interrupt instruction is used.

As an illustration of the use of interrupts, a program is given in Table 16. Not that the same results couldn't have been obtained without using this facility! The data given from address 0961 on corresponds to a series of sixteen words, one for each of the 'number' keys. If other words are required, the data can be derived from table 13. Note that each word must consist of 8 letters or less; if less than 8 letters are used, the remaining positions on each line must be filled with spaces (code 17).

#### Joysticks

Saved to the last, because we have very little experience with them ... The

basic principle is fairly straightforward, however.

Two addresses in the PVI, 1FCC and 1FCD, correspond to the left-hand and right-hand joysticks, respectively. When the flag is set, the vertical direction of each joystick is scanned and the results are stored at the corresponding address; if the flag is not set, the horizontal setting is scanned. The data in the two PVI addresses is only valid at the end of the frame — when the sense bit is at logic 1, in other words.

A low data value in address 1FCC or 1FCD corresponds to 'up' or 'right', depending on the setting of the flag during the previous frame (when the actual A-D conversion took place).

The actual range of values obtained varies from one joystick to another. Unfortunately! This means that it is not easy to write a program that is suitable in all cases. In fact, the 'space shoot-out' program on the new ESS recording does contain a joystick-scan routine ... but



0967	7710	PPSL, RS	
0969	0700	LODI, R3	
096B	F401	TMI, R0	
096D	1802/9802	BCTR/BCFR	preset R3
096F	0701	LODI, R3	
0971	440E	ANDI, R0	
0973	C2	STRZ, R2	
0974	D2	RRL, R2	3 x R0
0975	82	ADDZ, R2	
0976	0506	LODI, R1	
0978	81	ADDZ, R1	set R1, R2
0979	C2	STRZ, R2	
097A	0E4278	LODA, I-R2	
097D	5B04	BRNR, R3	
097F	D0	RRL, R0	
0980	D0	RRL, R0	
0981	D0	RRL, R0	
0982	D0	RRL, R0	
0983	44E0/440E	ANDI, R0	
0985	CD6829/ 6D6829	STRA/IORA, I/R1	
0988	CD6829	STRA, I/R1	
098B	F96D	BDRR, R1	
098D	7510	CPSL, R5	
098F	17	RETC, UN	
0990	7620	PPSU, II	
0992	3F0161	BSTA, UN	(clear/initiate PVI)
0995	04CC	LODI, R0	address preset
0997	C80F	STRR, R0	
0999	0702	LODI, R3	
099B	0610	LODI, R2	
099D	0508	LODI, R1	
099F	7710	PPSL, RS	scroll
09A1	3F02CF	BSTA, UN	
09A4	7510	CPSL, RS	
09A6	0E49CC	LODA, I-R2	Messline data
09A9	CD4890	STRA, I-R1	
09AC	5978	BRNR, R1	
09AE	04C4	LODI, R0	address preset
09B0	C876	STRR, R0	
09B2	7710	PPSL, RS	load Mline
09B4	3F020E	BSTA, UN	
09B7	7510	CPSL, RS	
09B9	0504	LODI, R1	
09BB	5A62	BRNR, R2	
09BD	FB5C	BDRR, R3	
09BF	7702	PPSL, COM	
09C1	1F095F	BCTA, UN	
09C4	01 0F 0C 0D		basic message data
09C8	01 0F 0C 0C		
09CC	0F 11 0A 10 17 00 0F 0F		
09D4	0F 11 0A 10 17 00 AA 17		

it's blocked! The text included with the record explains how to re-activate it. Obviously, this is a very unsatisfactory state of affairs. However, we have a solution. The program given in Table 17 can be used to test and 'calibrate' joystick controls. It reads the data in the two PVI addresses, with the flag both 'on' and 'off', and displays the results on the screen as follows:

```

FLAGON   (= horizontal)
1FCC 75  (= left)
1FCD AD  (= right)
FLAGOFF  (= vertical)
1FCC 11  (= left)
1FCD 83  (= right)

```

The data found at the two addresses is updated on the screen as required. The values given above (75, AD, 11, 83) are just examples, without any special meaning.

If the joysticks are wired as shown in the original article, address 1FCC should correspond to the left-hand joystick; 'Flag on' should correspond to vertical movement; and low data values should be obtained at the extreme 'up' and 'right' positions. Now, a request. If those readers who have a set of joysticks could let us know the results obtained (both with joysticks centered and in the various extreme positions) we can get some idea of the tolerances involved. It would also be interesting to know what value is obtained when no joysticks are connected - our prototypes read '0D' in that case. With this information, it should be possible to work out some kind of 'universal' joystick routine. Then we can start developing suitable programs!

### In conclusion

'And that' quoth he 'is that'. Practically all our experience, up to the minute of going to print, is included in these two articles. If we find any more tricks, you'll be the first to know. Meanwhile, we hope that you can start developing interesting programs!

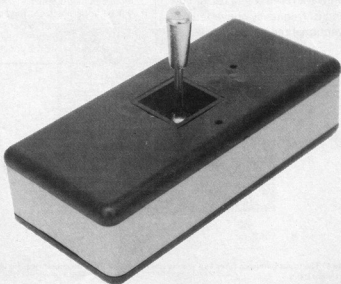

### Misprint

The information provided with the first ESS record for the TV games computer states that the speed of the 'surround' game can be modified by altering the data at address 0D02. Wrong! It should be address 0D20.

The circuit is simplicity itself. With S1 in the position shown, the aerial is connected to the input bandpass filter. This consists of two LC resonant circuits (L1, C1, C2 and L2, C3, C4), tightly coupled by C5.

The input filter is followed by a self-oscillating mixer stage, built around a dual-gate MOSFET (T1) and a crystal. The desired output frequencies are fed through a further bandpass filter consisting of three LC networks (L3/C9, L4/C10 and L5/C11) and a coupling capacitor (C12) to the aerial input of the medium-wave receiver. This receiver is used to tune in to the desired short-wave station.

# short-wave converter

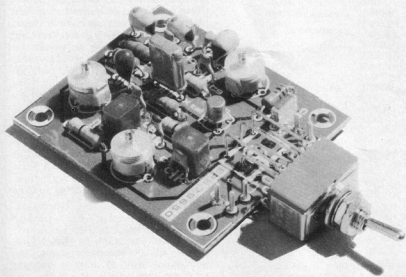

This simple crystal-controlled short-wave converter is intended for use in combination with a conventional medium-wave receiver — a car radio, for instance. One selected short-wave band is frequency-converted to the medium-wave band, so that the conventional receiver can be used to tune through the short-wave band.

The converter is preset to a particular short-wave band. Table 1 gives the values for L1, L2, C5 and the crystal for the various short-wave bands. If several different bands are to be available, these components would have to be switched; a simpler and more reliable solution is to build several converters.

In some cases, the short-wave band may not convert exactly to the medium-wave tuning range. If necessary, a slightly different crystal frequency can be used. The alignment procedure is straightforward:

- Tune in to a short-wave broadcast that is converted to approximately 1400 kHz, and adjust C12 for maximum signal strength.
- Tune in to a short-wave station that appears near 1500 kHz in the medium-wave band, and adjust C4 for maximum signal strength.
- Finally, adjust C2 for maximum signal strength at a station that appears near 1300 kHz.
- The adjustments of C4 and C2 are repeated until no further improvement can be obtained.

It will be apparent from the circuit that the other position of S1 connects the aerial direct to the medium-wave receiver and turns off the converter. ■

Table 1

Band (metres)	L1, L2 ( $\mu$ H)	C5 (pF)	X-tal (kHz)
75	8.2	10	2300
60	4.7	10	3600
49	3.9	10	4600
41	2.2	8.2	5800
31	1.2	8.2	8300
25	0.82	6.8	10500
19	0.56	5.6	13900
16	0.39	4.7	16400
13	0.27	2.7	20100
11	0.22	2.2	24400

Table 1. The input bandpass filter and the crystal frequency must be chosen for the desired short-wave band.

1

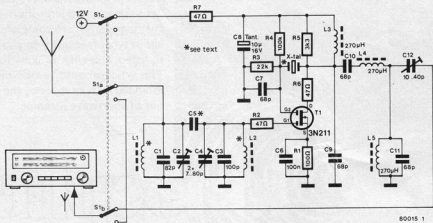

80015 1

Figure 1. Complete circuit of the short-wave converter.

2

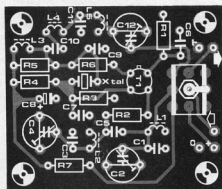
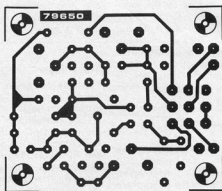

## Parts list

## Resistors:

- R1 = 100 Ω
- R2, R6, R7 = 47 Ω
- R3 = 22 k
- R4 = 100 k
- R5 = 3k3

## Capacitors:

- C1 = 82 p
- C2, C4 = 7...80 p (trimmer)
- C3 = 100 p
- C5 = see table 1
- C6 = 100 n
- C7, C9, C10, C11 = 68 p
- C8 = 10 μ/16 V, Tantalum
- C12 = 10...40 p (trimmer)

## Inductors:

- L1, L2 = see table 1
- L3, L4, L5 = 270 μH

## Semiconductors:

- T1 = 3N211

## Miscellaneous:

- X-tal = see table 1
- S1 = three-pole two-way switch

Figure 2. Printed circuit board design and component layout.

Why is long distance shortwave reception possible? Why is MW only good over short distances during the day? There are so many 'whys' associated with shortwave reception that many of us are completely in the dark about what frequency to choose, what time to listen, and what is likely to be heard. This article about the ionosphere is intended to take some of the guesswork out of shortwave listening.

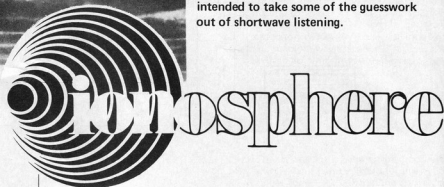

# ionosphere

Long distance radio communication is only possible because of the ionosphere — a region of the earth's atmosphere which is between about 90 and 320 km high (60 to 200 miles). Ionisation of the ionosphere is attributed to ultraviolet radiation from the sun. The ionised part of the ionosphere is not a single region, but is made up from several different layers.

causes television signals to be received over long distances. TV DXing is a very interesting hobby in itself, but is outside the scope of this article.

## The F layer

The area or region of the atmosphere which is the real workhorse of long distance communication is the F layer. It is about 280 km (175 miles) above the earth. During the day however, it splits into two separate areas, the F1 and F2 layers. They are located about 225 km and 320 km (140 and 200 miles) high respectively on days when the ionisation level is high. A good day! After sunset they combine back into the single F region. The maximum single hop distance of the F layer is about 4000 km (2400 miles) — see figure 2, which also shows the relative heights of the various layers. The F region is at such a high altitude that recombination of ions and electrons into neutral particles takes place at a very slow rate. The level of ionisation starts to decrease after sundown, and becomes progressively weaker until reaching its lowest level just before sunrise. This progressive decrease in the ionisation level can be noticed by the early disappearance of stations that were operating on frequencies close to the highest useful frequency of the day.

## The E layer

At about 100 km (70 miles) above the surface of the earth is the lowest useful region of the ionosphere, the E layer. The E layer is so low in the atmosphere that free ions have little distance to travel before they recombine with an electron, this forms a neutral particle which will not reflect radio waves. For this reason the E layer is only useful during the daylight hours and is usually much stronger around noon. It almost fades away after sundown.

A phenomenon worth mentioning is 'sporadic E' which is generally of little interest to the shortwave broadcast listener. Sporadic E's are made up of irregular patches of relatively dense ionisation floating in the E layer. These patches are usually found in equatorial regions, but also form in temperate climates in the summer months. However, they can appear at almost any time. The why's and wherefores are not completely understood, making E predictions virtually impossible.

Communication distance via a single E 'hop' is most common between 650 km and 2000 km (400 and 1200 miles) — see figure 1. Signals are generally very strong but may vary over wide ranges. Sporadic E is what usually

## The D layer

Below the E layer is a region of the ionosphere which doesn't help communications at all, but rather hinders it! This region is called the D layer. Radio transmissions on frequencies

Table 1

HF broadcast bands Frequency (kHz)	Band (m)
2300 - 2945	120
3200 - 3400	90
3900 - 4000	75
4750 - 5060	60
5950 - 6200	49
7100 - 7300	41
9500 - 9775	31
11700 - 11975	25
15100 - 15450	19
11700 - 17900	16
21450 - 21750	13
25600 - 26100	11

Table 2

Amateur bands Frequency (MHz)	Band (m)
1.8 - 2	160
3.5 - 4	80
7 - 7.3	40
14 - 14.35	20
21 - 21.45	15
27 - 29.6	10

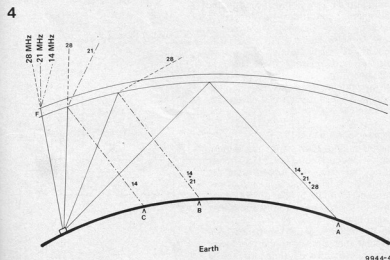
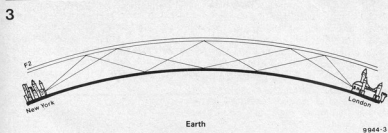
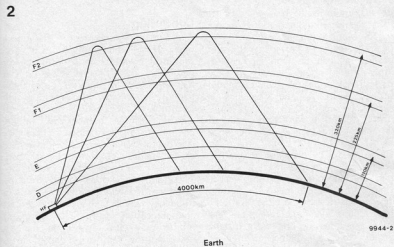
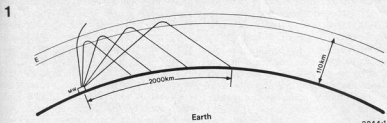

lower than about 4...8 Mhz can be almost completely absorbed (not reflected) by the D layer. Of course, the highest frequency absorbed and the amount of absorption is a function of ionisation, which is directly related to the height of the sun. The D layer is strongest during the noon hours in mid-summer. In the winter it is much less intense.

Only high angle radiation can manage to pass through the D layer and be reflected back to earth. Since low angle radiation is used for long distance communications it can be seen why only short distance communication is possible on low frequencies when the D layer is ionised.

### Recap

From the above discussion it is apparent that the relative reflectivity of the different layers of the ionosphere is greatly influenced by the sun. The F layer being the highest and most useful layer for long distance communication. It is useful around the clock, but becomes progressively weaker as the night draws on. The E layer is useful for much shorter communication distances, with the lower frequencies being reflected better. However, when the D region becomes ionised it begins to absorb those lower frequencies. This limits their use to short distance communication during the day.

This effect can best be heard at sunrise in the summer, by listening to the medium wave band. Before dawn many long distance stations should be heard, but as the sun starts to rise (first light) these stations will begin to fade away. Sometimes this takes only a few minutes. At dusk the long distance stations begin to be heard again and become increasingly stronger as darkness progresses.

### Sunspots and other effects

There are of course many things which effect the ionosphere and its ability to reflect radio signals.

#### Sunspots

Sunspots have, on average, an 11 year cycle between the minimum and maximum number of spots, however the cycle may vary between 9 and 13 years. The high and low number of spots vary greatly from cycle to cycle but usually the high count has sharper changes than the low. Sunspot cycles should not be thought of as being sinusoidal. There are times when the number of sunspots increase to a relatively high level during a period when the norm would be quite low. These isolated highs do not usually last for more than a few months.

During the low part of the cycle the ionosphere is relatively weak and high frequency reception conditions are at

their poorest. When the sun has a large number of spots the ionosphere is strong and communication is good up to the higher limits of the HF band (30 MHz ... 50 MHz).

#### SIDs and SWFs

Sudden increases in solar activity such as solar flares trigger very fast changes in the various layers of the ionosphere. When these conditions occur the variation in the absorption of the D layer is particularly sudden and may last from only a few minutes to a few hours. This suddenness has led to the term SID 'sudden ionospheric disturbance'. SIDs and SWFs (shortwave fade-outs) vary widely in intensity and duration, however the effects tend to be greater in times of high solar activity.

#### Solar radiation

There are two principle kinds of solar radiation, ultraviolet light and charged particles. The light travels the distance to earth in about 8 minutes and the effects on the ionosphere are fairly rapid. The particles on the other hand, are moving at a much slower speed and may take up to 40 hours to have any effect on communications. These effects are usually high absorption by the D layer and the production of an aurora, and they sometimes recur every 27 days — the rotation time of the sun. This recurrence can continue for as many as 4 or 5 rotations of the sun dependent on the strength of the original phenomenon.

#### Multi-hop

It is possible for a signal to 'hop' more than once, see figure 3. Even though ground reflections and ionospheric absorption take a toll on the signal strength, communications more than half way around the world are possible using multi-hop paths. The signal levels are usually somewhat lower and suffer higher distortion and more fading than do single-hop signals.

#### Fading

Fading is sometimes caused when the signal takes two or more paths before arriving at the receiver site with phase differences. If one or more of the paths are unstable, then the changing phase can completely obliterate the signal. Other things like weather fronts and moving air masses also tend to cause unstable radio conditions. The term fading covers an almost infinite variety of phenomena.

#### Angle of radiation and 'muf'

The angle at which the transmitted signal strikes the ionosphere has much to do with the 'skip distance'. The distance between the closest and farthest points that communication can be carried out on a given frequency is called the skip zone. In figure 4, point B is the shortest skip and point A is the

longest skip distance for 21 MHz, the distance between these two points is the skip zone. For 14 MHz the skip zone is between points A and C. By studying figure 4 it can be seen that low angle radiation, (the radiation leaving the antenna parallel with the earth's surface) has a longer skip distance than does the radiation going up at a greater angle, i.e. high angle radiation. It should be noted that the bending effect is not only dependent upon the angle at which the waves hit the ionosphere, but also on their frequency.

The 'maximum usable frequency' (muf) is the highest frequency that is usable for communications at a given time. The muf also has an effect on the skip distance, as can be seen in figure 4. With a muf of about 28 MHz only the very low angle radiation is being reflected back to earth. As the frequency is lowered the ionosphere appears more intense, therefore reflecting radiation that has higher angles of incidence (see 21 and 14 MHz). This effect can also be heard by listening in on frequencies close to the muf at a time when the ionosphere is getting weaker — the skip distance seems to get longer when in fact the closer stations, which require high angle reflections, are fading away leaving the more distant stations which are being reflected at lower angles.

It is apparent from the above discussion that for good long distance communication it is important that the antenna concentrates most of the transmitter power into low angle radiation. The receiver antenna should also be constructed so that most of its 'gain' is for low angle radiation. If shorter range communication is desired then a lower frequency should be used, together with a higher radiation angle to produce stronger signals.

#### Predictions

Making predictions about reception and ionospheric conditions is indeed a tricky business because there are so many variables. However, by taking into account as many known factors as possible, and relating them to past experience, it is possible to make general statements about band conditions at a given time for a given frequency.

#### Where and when to listen

The 90 m and 75 m bands are seldom usable beyond 300 km (180 miles) during the day, but longer distances are usual at night. Static and other atmospheric noise makes use of these bands in the summer months somewhat of a problem.

The 60 m, 49 m and 41 m bands have characteristics similar to the two lower bands except the daytime distance is much greater. These three bands also tend to stay open more often at night than do the higher frequency bands.

The 31 m, 25 m, and 19 m bands are the real DX bands. During high sunspot years they are open almost continuously. They are especially good in the dawn and dusk periods when the solar activity is low.

The 16 m and 13 m bands have very variable propagation which depends on the level of solar activity. During high solar activity the bands are good for very long distance listening, however, they become almost useless during periods of low solar activity.

#### Conclusion

The sun is the main factor that dominates all radio communications beyond the local level. Radio conditions vary with such obvious cycles as the time of day and season of the year. Since these parameters change with latitude and longitude it is possible to have an almost infinite number of unique communication variations. There are less obvious changes in the ionosphere which are also controlled by the sun, sunspots and other solar radiation. These and many other factors must be taken into account when selecting a frequency which will yield the desired communication path. The optimum results may not always be realised however, the familiarity gained from this article should help reduce the margin of failure and add greatly to one's enjoyment of shortwave listening.

M

# low voltage dimmer

As is well known, the NE555 IC contains two identical universal timers. The device is thus ideally suitable as the basis of a compact, low-loss dimmer circuit for low voltage lamps. One timer is used as a clock generator, whilst the other functions as a monostable multivibrator with variable pulse width.

As can be seen from the circuit diagram, only a few ancillary components are needed to complete the dimmer. The first timer of the NE555 is connected as an astable multivibrator and provides the required clock signal. The clock frequency is determined by the values of R1, R2 and C1, and is in the region of 1 kHz. The pulse width or duration of the clock pulses is thus approximately 10  $\mu$ s. The clock signal is fed to the trigger input (pin 8) of the second timer, which is connected as a monostable. The output of the monostable controls a power transistor (T1), which in turn switches the load (i.e. the lamp) on and off. Thus by varying the duty-cycle of the monostable (by means of P1), the

lamp is turned on for a greater or smaller length of time, thereby varying its intensity.

With the component values shown in the circuit diagram, the duration of the output pulses (pin 9) from the monostable can be varied by a factor of 10.

The maximum pulse duration (discounting the effect of P1) can be calculated from  $T = 1.1 \times R4 \times C2$ , which in the case of the circuit shown equals roughly 0.4 ms. Thus with a clock frequency of 1 kHz, the duty-cycle can be continuously varied between 60 and 96%, which in practice represents quite a suitable range. These values are obtained around the mid-position setting of P1. If the wiper of P1 is set to one of the end stops, the circuit will fail to function properly. For this reason it may be worth experimenting with various value resistors in series with P1 to make the adjustment range less sensitive.

The supply voltage of the circuit can lie anywhere between 5 and 15 V.

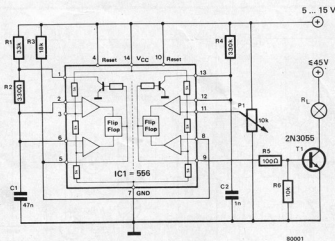

# I see your point



Whether a model railway is micro-processor-controlled or hand-operated, a visual display of the 'system status' is always worth while. If nothing else, it makes for an impressive control panel. For some functions, it is even essential to have a clear overview — unless, of course, your main aim is to realistically imitate crashes and derailments.

The points, in particular, are extremely important. As many model railway enthusiasts will have discovered, it is not at all easy to see what position the points are in from a distance. Even mechanical 'point position indicators' are not always particularly clear.

The indicator described here provides an unambiguous display on the main control panel. Different coloured LEDs can be used to provide a clear indication at a single glance.

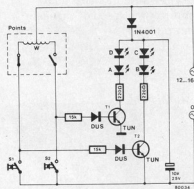

The circuit could hardly be simpler. Electro-mechanical points with built-in end switches are used. One of these switches is open and the other is closed when the points are set. The closed switch turns on the corresponding transistor, lighting one set of LEDs. The pushbuttons, electronics and one LED out of each pair can be mounted in the control panel; the other LED in each pair can be mounted alongside the tracks near the corresponding set of points, to give an on-the-spot indication.

As shown in the circuit diagram, two 6 V accumulators are used to power the circuit. The upper battery supplies the power when the boat is moving forwards; the lower one is only used for reversing, so it can be much smaller.

Potentiometer P2 is controlled by the servo. In the middle of its range, the voltage between the slider and supply common is zero. When the servo alters the setting of this potentiometer, a positive or negative voltage (depending

adjustment: the coupling between the servo axle and the potentiometer spindle is tightened when the relative position is correct. A small offset of the potentiometer can be compensated by adjusting P1: a voltmeter is connected between the slider of P2 and supply common, and P1 is adjusted so that the meter reads 0 V.

The next step is to set P3 to maximum. The servo is moved to one of its extreme positions — 'Full speed ahead', for

# servo speed control for model boats

The speed of a model boat can be controlled by varying the supply voltage to the main motor, via remote control. Normally, this control is fully electronic. In the circuit described here, however, a mechanical link is included: the remote control receiver drives a servo-motor and this, in turn, drives a potentiometer that controls the speed of the main motor.

on the direction in which it is rotated) is applied to the non-inverting input of IC1. The output of IC1 will therefore swing either positive (turning on T1 and T3) or negative (turning on T2 and T4). The main motor should be connected so that the boat moves forwards when T3 is turned on.

Zenerdiodes D1 and D2 and capacitors C1 and C2 take care of the stabilisation and smoothing of the reference voltages, so that power supply fluctuations have little effect on the motor control. Even so, it is advisable to include interference suppression on the main motor.

The first step when setting up the unit is to make sure that the mid position of P2 corresponds to the neutral position of the servo. This is a purely mechanical

instance — and P3 is slowly turned down until the maximum permissible voltage across the main motor is obtained. Not more than 6 V are available, obviously, but this adjustment makes it possible to use lower voltage motors without danger of burning them out.

The transistors need adequate cooling. A heatsink with a thermal resistance not greater than 2.8°C/W should be used, and the transistors must be mounted using mica insulating washers.

(U. Passern)

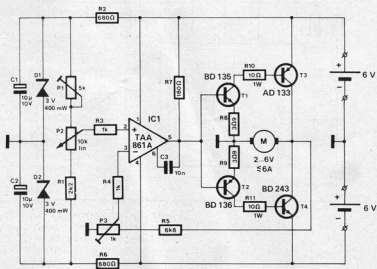



# market

## Micro keyswitches

Modern Electronic equipment has long been in the forefront with regard to miniaturisation, conserving both space and energy.



This in turn has made control of access to circuitry even more essential in view of the high portability of equipment.

Whereas miniature switches are available for such applications, lock cylinders have tended to remain of much larger dimensions causing difficulty in mounting (space problem) and having low security value.

A considerable uplift in quality and security is now available in the new MICRO KABA Locking Cylinder. The internationally well proven advantages of the Kaba design are packed into a tiny 12 mm diameter cylinder operated by a key that can be inserted either way up. Eight pairs of tumblers offer over 10,000 key combinations. High grade brass and nickel silver precision engineering and the well tested security of the Kaba design over several decades, give improved functioning and long life. The universal cross-shaped profile of the MICRO KABA cylinder makes it possible to achieve secure assembly into switch housings.

The range includes versions with one or two key withdrawal positions.

Micro Kaba is not only suitable for electrical key switch applications but also for general use in original equipment where small size is essential. This opens up new possibilities with the use of a tiny lock having big security features.

*Kaba Locks Limited,  
Woodward Road,  
Howden Industrial Estate,  
Tiverton, Devon EX16 5HW,  
Tel.: Tiverton (08842) 56464,  
Telex: 42564.*

(1305 M)

## Single board microcomputer

Fairchild have recently launched their 'Spark-16' microcomputer boards in the UK. The heart of this very powerful microcomputer is Fairchild's recently introduced 9440 'Microflame' CPU, a 16-bit, 10-12 MHz bipolar microprocessor. Assembled on a board

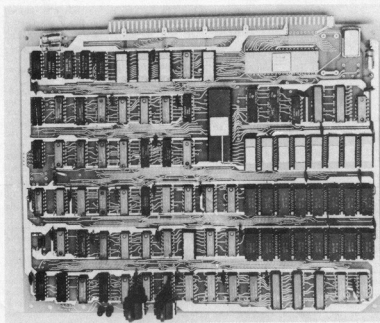

measuring eight inches by ten inches it is suitable for applications requiring input/output capability or for use as a basis for more complex systems. The main features of the 'Spark-16' microcomputer are 8 K bytes of dynamic RAM, 4 K bytes of PROM, memory control with direct memory access capability. All input and output lines are TTL-compatible. The serial port features a switch for selecting either RS232C or 20 mA current loop operation. A total of thirteen data rates, between 50 and 9600 baud, are also switch selectable. Memory and I/O expansion can be achieved via an S100 size edge connector.

The 4 K byte on-board PROM can be supplied with 'Firebug', as a resident program. This is an interactive assembler, debugger, editor and monitor designed for program generation in assembler language and evaluation of the 9440 'Microflame' system. 'Baby BASIC' is available in PROM as an option. The 'Spark-16' contains 50 basic instruction types for a total of 2192 different instructions with eight addressing modes.

*Fairchild Camera and Instrument (UK) Ltd.,  
230 High Street, Potters Bar,  
Herts, EN6 5BU,  
Telephone: Potters Bar (0707) 51111.*

(1309 M)

# market

## Plastic case for handheld electronic products

New from Continental Specialties Corporation is a grey plastic case specifically designed for small, portable electronic products such as handheld calculators, counters, remote-control units, communication devices, portable meters, benchtop projects and telephone accessories.

Based on the case designed for CSC's series of handheld frequency counters, the case measures 3 x 6 x 1½ inches (76 x 152 x 38 mm), and comes complete with assembly screws, a screw-in antenna connector, a red transparent plastic front panel, a subminiature jack preconnected to a battery snap connector, and a battery compartment cover. The front panel provides sufficient space for keyboards, speakers, microphones or controls.

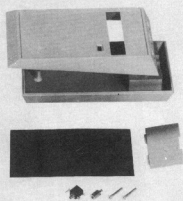

Customer specified colours can be provided for orders of 1000 units or more.

*Continental Specialties Corporation,  
Shire Hill Industrial Estate,  
Saffron Walden,  
Essex CB11 3AQ,  
Telephone: Saffron Walden (0799) 21682.*

(1308 M)

# market

# market

the iron in use has reached the required temperature. The circuit also incorporates a 'fail-safe' system to prevent excessively high temperatures.

*Antex (electronics) Limited,  
Mayflower House,  
Plymouth, Devon,  
Telephone 0752 - 67377.*

(1302 M)

## Soldering on

A new soldering station is now being produced by Antex (Electronics) Limited. The TCSU2 has a temperature range of 270°C-430°C with a visual indication of the soldering iron tip temperature. Four square LEDs, as shown in the photograph, will light showing tip temperatures of 270°, 300°, 330° or 360°C.

The new station will be supplied with the XTC - 50 watt or the CTC - 40 watt miniature soldering iron, both irons being fitted with a thermocouple sensor and operating on the fully earthed 24 volts supply from the soldering station. The irons are supplied complete with 3 long life iron-coated bits with tip sizes of 0.5 mm, 1 mm, 2.3 mm for the model CTC and 2.4 mm, 3.2 mm and 4.7 mm for the model XTC. Burn-proof silicone covered 5-core cable connects the thermocouple sensor in the tip of the iron with the electronic circuit of the soldering station. Zero voltage switching ensures the absence of transient spikes. Current leakage is negligible and the accuracy of temperature settings is about 2%. The mains, switch, light and fuseholder are all easily accessible at the front of the unit. An on off light shows when

## New digital multimeters added to the TM500 range

The latest entries to the Tektronix TM500 series of modular instruments are two 3½ digit Multimeters, the DM505 and the DM502A.

The DM505 intended for applications where low capital cost is important and provides the five basic measurements of DC voltage and current, AC voltage and current, and resistance in two ranges, (high and low).

With the high/low resistance feature, the low setting is used for in-circuit measurements where it is important not to forward bias diode junctions. The maximum imposed voltage is 0.2 V in the low resistance range, and 2.0 V in the high range, the latter being useful where actual measurement on diode junctions is needed.

Extra features on the DM502A are dBV and dBm measurements, a fast-response temperature range of -55°C to +200°C, true RMS readings, and autoranging for volts, ohms and dB measurements.

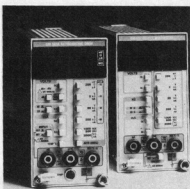

The DM502A's combination of autoranging and dB measurements make it an excellent choice for communications applications. In addition to the convenience of autoranging, the DM502A provides direct readout on the display of the total dB reading. There is no need for the mental addition of a scale setting to the display readout. This saves time and eliminates a potential source of error.

Pushbutton selection of all functions and ranges plus easy-to-read half-inch LED display digits make the DM505 and DM502A fast and easy to use. A choice of front panel or rear connector inputs is selectable by push-button, a feature which allows easy interconnection with other TM500 instruments while retaining the ability to revert to external measurements when needed.

*Tektronix U.K. Ltd.,  
Beaverton House,  
P.O. Box 69 Harpenden,  
Hertfordshire,  
Tel.: Harpenden 63141.*

(1284 M)



## New silicone encapsulants for electronics

A new range of Kömmerling 2-component silicone compounds, primarily intended for encapsulation and sealing in the electrical and electronics industries is now available in the U.K. through L.B. Chemicals Ltd.

The materials are available in soft and medium grades, the soft grades being used where protection from vibration is required while the medium grade is a general purpose coating and encapsulating product.

Advantages of the products include widely variable processing times by simple alteration of catalyst ratios, low shrinkage, easy peel-off for repair work and excellent electrical and moisture protection.

The materials cure at ambient temperatures without evolution of heat and are thus suitable for treatment of delicate assemblies which would be damaged by elevated temperatures.

*L.B. Chemicals Ltd.,  
216 Moss Lane,  
Bramhall, Cheshire,  
Tel: 061-440-9559.*

(1285 M)

# market

# market

## Between sensor and processor

With microprocessors in mind, Siemens has designed a new mos device which converts analogue sensor signals into digital pulses. Designated SAB 3060, this analogue-to-digital converter has a standard 8-bit word length. One of the principal features of this new device is an integrated capacitor network to achieve a very high conversion linearity. The SAB 3060 compares each incoming analogue signal eight times with a sub-divided reference voltage. In each case, it is determined whether the measured value is larger or smaller than the particular reference value. First, half the reference voltage ( $V_{ref}/2$ ) is offered, followed by  $V_{ref}/4$ ,  $V_{ref}/8$  and so on until the eighth value is reached ( $V_{ref}/256$ ). By means of this successive approximation, the original analogue value is directly converted into a digital 8-bit word.

Originally, resistor networks were used for the approximation process. Capacitive cells, however, are more suitable for mos technology. Parasitic capacitances capable of falsifying the result can be suppressed by judicious arrangement of capacitors. Additional driver amplifiers are not required, as the voltage sources for the measured and reference values are only capacitively loaded.

The SAB 3060 is a 18-pin d.i.p., the supply voltages are +5 V and +12 V. The measuring range extends from 0 to +8 V, the reference range from 1 V to 8 V. Special care was taken to achieve a linearity of  $\pm 2$  l.s.b. (least significant bit), in other words  $\pm 0,08\%$  of the range final value. The precision is  $\pm 1$  l.s.b.

The SAB 3060 has as its core a charge equalisation converter, which is to be seen in the circuit layout (see photo) as a central capacitance field with a total of 256 m.o.s. capacitors. Measured and reference values are compared in the comparator, from where the digital 8-bit serial information is passed to the converter register. By way of result and output registers and an output driver, the digital value is then presented in parallel form. Output and converter controls are also integrated.

Around 1000 transistors and other elements are on 7.5 mm<sup>2</sup> of silicon.

The SAB 3060 is intended as a link between sensors and microprocessors, e.g. when sensors acting as the 'five senses' need to supply direct information on a variety of status such as speed, temperature spacing, length or quantity. When supplied with such values in digital form, microprocessors or microcomputers can subsequently issue instructions for analogue processes by way of actuators. These actuators close the loop between automatic detection and a specific response.

Siemens Limited,  
Siemens House, Windmill Road,  
SUNBURY-on-THAMES,  
Middlesex TW16 7HS.  
Tel: (09327) 85691.

(1281 M)

# market

## Liquid crystal displays

A new range of liquid crystal displays from Industrial Electronic Engineers, and designated IEE-POLARIS, are now available in 2 models: *high performance* for use in relatively severe environments, and *economy* for use in mild environments.

Both models are available with either reflective or translucent polarizers and come equipped with DIL strip connectors for ease in mounting to PC boards or standard sockets. The user can mount the display with connectors in such a fashion as to allow replacement of the display without removing the two connector strips from their fixed position.

These LCDs feature: 3½ to 8 digits, .350" to .700" character height, low 25 µW typical average power consumption, choice of 3 to 9 or 4.5 to 13.5 voltages, and temperatures of -10° to +55° C.

IEE's LCDs, which are direct sunlight-readable, can be displayed continuously for up to two years without battery change, and are compatible with available low power, low voltage, CMOS drive circuitry. The crystal



material is environmentally tested for stability and the package hermetically-sealed to assure a long life of greater than five years. Custom models are available using the customer's font or numeric style together with symbols, decimals, etc.

IEE,  
7740 Lemona Ave.,  
Van Nuys, CA 91405, U.S.A.,  
Tel.: (213) 787-0311.

(1301 M)

## Floppy disc controller from GECS

GEC Semiconductors have announced a single-board Universal Floppy Disc Controller called the iSBC-204. This is fully compatible with the new Intel iSBC-80 or iSBC-86 single-board computers and with most single-density, soft-sectored standard and mini floppy disc drives.

The iSBC-204 controls two drive surfaces. However, with the addition of a second Intel 8271 floppy disc controller, up to four drives can be supported.

It has a direct memory access channel allowing single-board computers to process in parallel with disc transfer operations, and programmable track-to-track access, head settling and head-load times. The wide drive compatibility range of the iSBC-204 is achieved without compromising performance by program control specifying the operating characteristics.

The controller can read, write, verify and search either single or multiple sectors and has on-board data separation logic performing standard FM encoding and decoding.

The iSBC-204 can be mounted in one-slot Intel iSBC system chassis or iSBC-604/614 card cage and interface with the drive(s) on either low-cost flat ribbon cable or twisted-pair conductors with individually wired connectors.

GEC Semiconductors Limited,  
East Lane Wembley,  
Middlesex HA9 7PP,  
Tel.: 01-904 9303.

(1287 M)

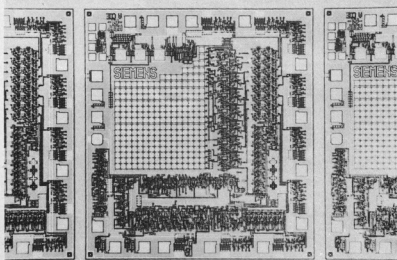

# market

# market

## Component tester

MTL Microtesting Limited have recently announced their appointment as sole UK distributor for Huntron Instruments, the manufacturers of the Huntron Tracker which is the first of a new generation of portable test equipment incorporating a new technique for detecting and isolating faulty components either 'in' or 'out' of circuit. The Tracker utilizes a 'scope display, two non-polar leads and three impedance ranges to test a broad range of solid state components such as integrated circuits, bipolar transistors, field effect transistors, diodes, LEDs, unijunctions,

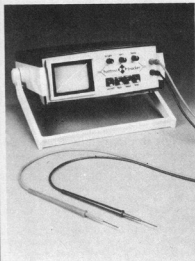

gate control switches, capacitors etc. Simple easy to understand 'scope images visualise the condition of a device under test, indicating 'shorts', 'open circuits' and 'leaks'.

*MTL Microtesting Limited,  
1-15 The Butts Road,  
Alton, Hampshire,  
Telephone: Alton (0420) 88022.*

(1307 M)

## New range of hand tools

The new Profil 2000 range of hand tools from OK Machine & Tool (UK) Ltd is the result of extensive technical and ergonomic research. Apart from their appearance, which is unconventional, the tools have other significant differences including sweat absorbing handles and total rustproofing to contribute towards comfort and durability.

Initially the range comprises various types of pliers, screwdrivers and hammers suitable for electrical, mechanical and general engineering use. The pliers, made of high alloyed carbon-steel with hardened cutters, have unique sweat absorbing handles and are finished like the other tools in the range in black chromium plate. Several types are available including wire cutters and strippers as well as fine nose strippers. The screwdrivers have red PVC and black Cellidor padded handles with chrome

vanadium blades. Wide, narrow and Phillips types are available. Plastic handles are an unusual feature in the hammer range and a totally secure patented connection between metal head and the handle is used. Cushion hand grips are fitted which, it is claimed, absorb virtually all shock.

*OK Machine & Tool (UK) Ltd.,  
48a The Avenue,  
Southampton,  
Hants SO1 2SY,  
Telephone: 0703 38966/7*

(1303 M)

# market

## Digital multimeter

Recently announced by Telonic Berkeley UK is the Data Tech 3½-digit, six function digital multimeter produced by a division of the American Penril Corp. The Model 30LC has a basic DC accuracy of 0.1%. A large 0.5" high Liquid Crystal Display (LCD) is used for low power drain from four off-the-shelf, dispos-

able, size D flashlight batteries. Either alkaline or zinc-carbon batteries may be used. When using alkaline batteries, up to 2400 hours of battery life from one set of batteries is possible if measuring DC voltages and over 1300 hours with average use of all six functions. The Model 30LC uses a single DVM LSI chip for its analogue to digital conversion. Automatic zero and polarity are included. Function and range can be selected by rotary switches.

Functions include AC and DC voltage and current, resistance to 0.1 ohm resolution and a diode test feature. A low battery sensing circuit flashes LOW BAT symbol in the LCD display area when approximately 100 hours of operation remains prior to battery replacement. Batteries can be changed in less than one minute. When the input exceeds 1999 counts, overrange is indicated by the three least significant digits blanking while the most significant digit '1' stays on. The instrument is packaged in a high impact plastic case with metal top and bottom.

Options include internal 10 amp current range, carrying case, RF probe, high voltage probe and demodulator probe.

*Telonic Berkeley UK,  
2 Castle Hill Terrace,  
Maidenhead,  
Berkshire SL6 4JR,  
Telephone: 0628 28057.*

(1304 M)

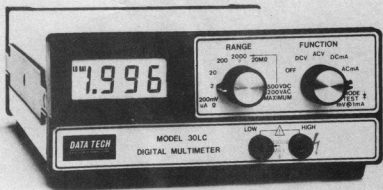

Price £2.38 (inc Postage and Packing) USA and Canada \$4.00  
 Available from Elektor Publishers Ltd., Kent, CT1 1PC.  
 (please use Elektor readers service order form in this issue)

## The Elektor cassette-binder

## for your copies of Elektor

It is evident that in your profession and/or hobby the design ideas published in Elektor are referred to time and time again.

We are therefore now introducing this new cassette style binder to keep your copies of Elektor clean and in order.

The chamfered corner of the cassette allows instant recognition of each months issue without the need to thumb through pages of previous months issues.

No wires or fastenings are used so copies are easily removed and replaced and each cassette will hold one year's volume of Elektor. Their smart appearance will look good on any laboratory shelf.

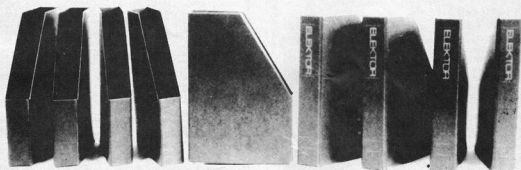

## PORTABLE PRECISION

A range of 3½ digit LCD multimeters offering high precision and extended battery life. All feature 0.5" LCD read-out with 'battery low' warning, inputs protected against overloads and transients, Auto-polarity, Auto-zero, rugged ABS cases and a full 1-year warranty.

The LMM-200 is a compact handheld multimeter with 0.5% basic accuracy and 15 different ranges. It measures voltage from 0.1mV to 500V, current from 0.1µA to 2 Amps, and resistance from 0.1Ω to 2MΩ.

The LMM-2001 is an identical instrument but with 0.1% basic accuracy.

The LMM-100 has an adjustable handle, a 2,000 hour battery life and is ideally suited to field or bench use. It measures voltage from 0.1mV to 1KV, current from 0.1µA to 2 Amps, and resistance from 0.1Ω to 20MΩ. 0.1% basic accuracy.

Lascar Electronics Ltd., Unit 1, Thomasin Road, Basildon, Essex.  
 Telephone No: Basildon (0268) 727383.



	£	P & P	VAT	TOTAL
LMM-200	34.95	1.00	5.39	41.34
LMM-2001	44.95	1.00	6.89	52.84
LMM-100	69.95	1.50	10.72	82.17
TEST LEADS	1.95	0.25	0.33	2.53

To: Lascar Electronics, Unit 1, Thomasin Road, Basildon, Essex.

Please send me Data:

LMM-100 £82.17 LMM-200 £41.34 LMM-2001 £52.84 TEST LEADS £2.53

Name \_\_\_\_\_

Address \_\_\_\_\_

Tel No \_\_\_\_\_

I enclose cheque/P.O. value \_\_\_\_\_

**BREAD  
BOARD****1979**

### **There's a lot going on at Breadboard!**

Seventy exhibitors showing and selling everything that the hobby electronics enthusiast could want! Demonstrations of electronic organs — computer kits — audio gear.

Radio Station S22 broadcasting throughout the show. See your voiceprint! Get your own weather details direct from Tiro's M! Test your reactions — and your strength.

Careers in Electronics — get the advice and information that could start you off on a rewarding and interesting career.

**It's worth going to Breadboard!**

**Royal Horticultural Halls Elverton Street  
Westminster London SW1**

**December 4-8th 1979**

**Admission £1 (students 70p)**